

May 15, 2026

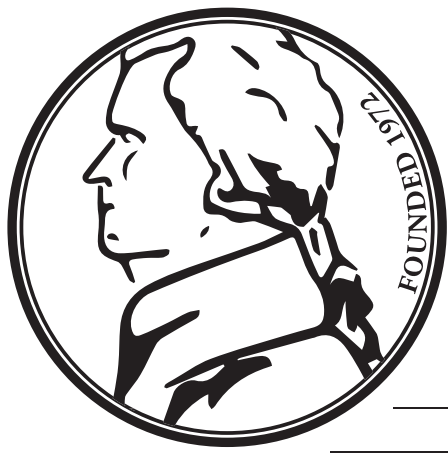

# get your NICKEL'S WORTH

One Free Copy

VOLUME LV, NUMBER 5 • Circulation 26,010 • Serving Northern Idaho, Western Montana & Spokane Valley

Classified Ad Dept: 208-667-0651 • Display Ad Dept: 208-667-2408 • Web: [www.nickelsworth.com](http://www.nickelsworth.com) • Email: [ads@nickelsworth.com](mailto:ads@nickelsworth.com)

2026 HOME IMPROVEMENT SPECIAL ISSUE PAGES 13-20

**Pages 4 & 5**

**Pages 6 & 7**

**PAGE 10**

**PG 16**

**Page 18**

**Page 19**



ALL PHASES OF construction. Big or small, we do it all. 10 years of experience, locally owned, licensed, insured and work comp policy. Stensland Construction, call or text us for your free estimate, 208-704-7135

CDA YARD SALE! 7am-4pm Friday-Saturday, 5/15-5/16, 3380 W. Parla Dr. Assorted military and hunting gear, 280 caliber rifle with ammunition, gas edgers, china set, vintage Harley tank and assorted household goods. It all needs to go!

SPOKANE: 100+ HOME, yard, and garage sales in Northwood and Sandy Ridge off Argonne and Upriver Rd. Friday-Saturday, May 15th-16th, 9am-4pm, and Sunday, May 17th, 9am-2pm

### PLACE YOUR AD

208-667-0651 or [nickelsworth.com](http://nickelsworth.com)  
Use the Mail-In Ad Form on page 30  
Please have ads in by Weds. at 3pm



Index - Page 2



AUCTION NORTHWEST, LLC



MISC. EQUIPMENT & VEHICLE AUCTION  
May 15-20 • In-person preview: May 14-16

Taking consignments, call to verify if we have space



208-994-6003 • [auction-nw.com](http://auction-nw.com)

3156 Beck Rd, Hauser, ID Open Tue-Fri 8am-4pm

CDA HUGE RECORD/ CD Sale! Most like new. 9am-4pm Friday-Saturday, 5/15-5/16, 2809 N. 6th St.

POST FALLS CUSTOM Cups and stuff yard sale— that's right, it's a yard sale because it's in the yard, and it's custom cups, puzzles, coasters, acrylic plaques, and more. Many items already created for you to choose from, and specialty items can be created on site immediately. Saturday, May 16th, 9am-5pm, 3153 E. Thrush Dr. No early birds please

PLANT SALE BY ROSE Lake Historical Society, Hwy 3 at Old Rose Lake School, Saturday-Sunday, May 16th-17th, 9am-1pm. Trees, annuals and perennials, vegetable starts, flower pots, and yard art. Indoor yard sale, collectibles, vintage items, clothing, seasonal decor, housewares. Rose Lake, ID

NICKEL'S WORTH CLOSED Monday, May 25th, in observance of Memorial Day. Regular hours resume at 8am Tuesday, May 26th. Visit us online any time at [www.nickelsworth.com](http://www.nickelsworth.com)

SHOPS • GARAGES • BARN • POLE BUILDINGS



24/7 AVAILABILITY  
CALL US TODAY  
888-672-1249

STEEL STRUCTURES AMERICA INC.

NORTHWEST'S LARGEST POLE BUILDING CONTRACTOR  
[SteelStructuresAmerica.com](http://SteelStructuresAmerica.com) • (888) 672-1249

**VOTE Lauren Traw**  
FAITH • FAMILY • FREEDOM



I'm running for Republican Precinct Committeeman because I believe in serving my community and strengthening our local Republican Party. I was raised with a strong commitment to conservative values like limited government, individual liberty, fiscal responsibility, and respect for the Constitution. Through my work in business and supporting local campaigns, I've developed strong leadership skills and understand what it takes to earn voters' trust and win election. I'm committed to listening, working alongside my neighbors, and helping Republicans succeed through organization, outreach, and results. I would be honored to earn your vote. - Lauren Traw

The future of Idaho is decided by those who show up! Vote May 19th



Scan QR Code to:  
• Request an absentee ballot  
• Check your voter registration  
• Find your polling location  
Or visit [VoteIdaho.gov](http://VoteIdaho.gov)

Precinct 303

Make your plan to vote: Absentee • Early In-Person • Election Day

Lauren Traw, Rathdrum, ID, Precinct 303



# ALLYSON KNAPP

FOR ASSESSOR

Paid for by the Committee to Elect Allyson Knapp. Susan Weathers, Treasurer

Saving You Tax Dollars with Accuracy

## RE-ELECT A STEADY VOICE FOR NORTH IDAHO



★ ELAINE ★  
**PRICE**  
4B STATE REPRESENTATIVE

- ✓ PROVEN CONSERVATIVE
- ✓ DEFENDING IDAHO VAULES

### REP. ELAINE PRICE

STATE REPRESENTATIVE ★ DISTRICT 4B

REPUBLICAN PRIMARY ★ MAY 19

Learn more at: [elaine4cda.com](http://elaine4cda.com)

PAID FOR BY ELAINE 4 CDA, RICHARD PRICE, TREASURER

A VOICE FOR THE PEOPLE

**JOHN PADULA**

FOR COUNTY COMMISSIONER, SEAT 1



VOTE IN PERSON ON MAY 19TH!



"I stand for excellent service to the community, transparent and limited government, and responsible fiscal practice. I plan to strengthen community protection while upholding law enforcement accountability. I will support sensible growth management, the preservation of local businesses, the culture we love, and community values."

- John Padula

[Padula4Commissioner.com](http://Padula4Commissioner.com)  
[Padula4Commissioner@gmail.com](mailto:Padula4Commissioner@gmail.com)

- ✓ PUBLIC SAFETY
- ✓ LIMITED GOVERNMENT
- ✓ FISCAL RESPONSIBILITY



Visit my Website!

PAID FOR BY JOHN PADULA FOR COUNTY COMMISSIONER, TREASURER DEBBIE HICKS

KOOTENAI COUNTY COMMISSIONER, SEAT 1

Voter Guides Available Now!

# WATCHMEN Ministry NORTH IDAHO

Non-Partisan Voter Guides for the May 2026 Election for Kootenai, Bonner, Boundary, & Shoshone Counties

- Precinct Committeemen
- County Commissioner
- County Assessor
- County Clerk
- County Treasurer
- Legislative Races
- Judicial Races



[WatchmenMinistryNorthIdaho.com](http://WatchmenMinistryNorthIdaho.com)

Be an informed voter! We provide the candidates' complete answers so you decide who best represents your values! That's what being an INFORMED Voter is!

Paid for by Watchmen Ministry North Idaho

## YOUR PERFECT APPLIANCE STARTS HERE!



**SAMSUNG** In stock NOW!

**PRO HOME CENTER**

Like us on Facebook for current sale updates!

208-267-7561

**buckshot barber north**



"outlaw edition"

**GRAND OPENING**  
FRIDAY, MAY 15TH, NOON-5PM

**"MEAT" & GREET**  
Meet the barbers and grab a soda & some grub!

Food by **Bully Dogs in Da House**, hottest buns in town & **Garrett Bakes Gourmet Cookies**, voted best cookies in the USA (by us)

**6101 HWY 54, ATHOL, IDAHO**

Regular hours resume Saturday • Walk-ins 8am-6pm  
[BuckshotBarberBeBadass.com](http://BuckshotBarberBeBadass.com)

## Garage Sales & Miscellaneous

**49th Annual**  
**ST. REGIS MEMORIAL DAY**  
**FLEA MARKET**

*Montana's Largest!*  
**MEMORIAL WEEKEND**

Sat-Mon, May 23, 24 & 25  
Daylight to Dusk

**BREAKFAST BARGAINS CONCESSIONS**

Take Exit 33 off I-90  
Follow signs to Community Park & Community Center  
Pets in park must be on leash and in your control. No bikes in park.

**For more information**  
406-280-0009 / [StRegisMTFleaMarket@gmail.com](mailto:StRegisMTFleaMarket@gmail.com)

YOUR FRIENDLY LOCAL free classified paper since 1972: the Nickel's Worth

**ATHOL SEVEN12RANCH** Horse Rescue and Sanctuary Hay Fund Yard Sale 8am-5pm Friday-Sunday 5/15-5/17, 12512 E. Hummingbird Lane. Vintage collectibles, horse stuff, furniture, housewares, barrels, row boat, snowmobile, \$5 bag sale of clothes and much more! Come support a local non-profit serving the northwest since 2021. If you can't attend and still want to support the ranch, you may do so on the website at: seven12ranch.org

**CDA HUGE MULTI-FAMILY** Sale! Lots and lots and lots! 1213 E. Wallace Ave. 7am-2pm Friday-Saturday 5/15-5/16

**CDA ANNUAL BLUE WOLF** Community Club Plant and Yard Sale 5/15-5/16. 8am-4pm Friday-Saturday; half price Saturday, that means \$1.50 plants! Nice variety of plants, annual, perennial, vegetables and berries. 2000+ sq. ft. of second hand treasures. Many 25¢ through \$5 including outdoor items, and jacuzzi tub. Refreshments available. 4479 S. Blue Creek Rd.

**POST FALLS HUNTERS** Glen Neighborhood Annual Garage Sale! When: Saturday 5/16, 8am-2pm. Location: East of Kiwanis Park

**COLLIGAN'S AUTO** Service, 208-889-9547, 5250 E. Seltice Way, Post Falls. We're offering a free computer system scan! Domestic and Asian cars and trucks. Limited time offer! Come in today!

## HENRY'S



### COUNTRY STORE

**HENRY'S COUNTRY** Store is now open in Oldtown, ID. We carry regional and gourmet foods, as well as a wide variety of unique kitchen, home, and bath essentials. Henry's has old-time country store vibes and aims to give shoppers a fun and nostalgic experience. Come visit us today at 54 Selkirk Way, Ste. B in Oldtown, Idaho. Open Monday-Saturday, 9am-5pm. Call us at 208-437-3680 or visit our website: [henrys.countrystore.com](http://henrys.countrystore.com)

**HAYDEN YARD SALE**, 8am-4pm, Friday-Saturday, 5/15-5/16, no early birds. 10489 N. Seaside St. off Miles. Old ox yoke, 95 lb. anvil, cast-iron banks, old clocks, yard art, rusty horseshoe flowers, rusty wheels, hand water pump, water trough, milk cans, rope, early 1900s pergola top, large metal wheel, old wooden ladder, wooden garden gate, crates, wooden sleigh, wood porch columns, buckets, tackle box, old hot rod car parts, and much more!

**AW, YOU REALLY LIKE US** "The item sold and I really think it had everything to do with the Nickel's Worth. I'm very pleased!" Kim, May 2025, customer since 2003

### Musical Instruments & Instruction

**BEAUTIFUL FREDERICK** Stein baby grand piano, \$500. Black polished wood finish, signed by maker in Chicago. Family heirloom, gorgeous piece. You pay to move from downtown Cda. Text 208-651-6219 for info

**HAYDEN MULTI-FAMILY** Barn Sale. Tools, plants, jewelry, camping, horse bits, collectibles, miscellaneous. Rain or shine, in historic barn, 15718 N. Rimrock. Saturday-Sunday, 5/16-5/17, 9am-4pm. Cash

**CDA GARAGE/ ESTATE** Sale. Lots of framed prints from Alaska artists, tactical gear, Ethan Allen dining table, lots more. Priced to sell! Friday 8am-noon, Saturday 8am-1pm, 5/15-5/16, 330 Mill Ave.

**CDA ESTATE SALE** Conducted by Orchard Ridge Senior Living Estate Sale Volunteers to benefit the non-profit assisted living facility. Thursday 2pm-6pm, Friday 8am-2pm, Saturday 9am-noon, 5/14-5/16. Discounts on Saturday. You must bring your own help with large purchases. Cash or check only. 1410 W. Ashmont Way. This upcoming sale is filled with beautiful, well-kept furniture, timeless decor, vintage treasures and unique household pieces that have been collected over many years. Every room offers something special from elegant entertaining pieces to comfortable everyday furnishings that still have plenty of life left in them. Some of the standard pieces include a stunning dining room set with 10 chairs accompanied by a matching china hutch and buffet/ server that makes an incredible statement together, also a beautiful grandfather clock that adds warmth and character to any space. There is an end of bed bench as well as a queen bed, headboard, and night stands along with various pieces of furniture. You'll also find a comfortable leather-like couch and loveseat set, coffee table, Western sofa table, wooden coat tree, accent chairs, floor and table lamps, artwork, fine china, collectible glassware, office filing cabinets, bookcases, storage shelving, totes, books, holiday decor, kitchenware, women's clothing and shoes, accessories, perfume, high-end costume jewelry and many one-of-a-kind vintage finds throughout the home. This is the kind of estate sale where you'll want to take your time walking through. There's something interesting around every corner. Whether you're furnishing a home, decorating a space, collecting vintage pieces or simply love treasure hunting, this sale is worth the stop

## Oldtown Flea Market

----- Buy • Sell • Barter • Yard Sales -----

Open 9am-5pm Friday, Saturday & Sunday, May 1st thru Sept 30th!

1332 Highway 2, Oldtown, ID • On Google & Facebook • 10x10 spaces \$10 per day • Sign-up is on Thurs • 208-946-8226 or 208-946-1514  
We will have our vendor Jack with guns & ammo all month!

## Index

MAY 15TH, 2026

<b>AD FORM</b> .....	30	Hunting & Firearms.....	12
Acreage.....	30	Keeping Warm.....	32
Antiques.....	28	Lost & Found.....	11
Apartment Duplex for Rent.....	30	Manufactured Homes.....	30
Auctions.....	10	Miscellaneous.....	1-10
Automobiles.....	24	Motorcycles & ATVs.....	11
Boats.....	26	Movers.....	20
Classic Vehicles.....	24	Musical Instruments.....	2
Computers & Electronics.....	32	Painters.....	17
Electricians.....	17	Parts & Accessories.....	24
Employment.....	23	Pets.....	27-28
Farm Animals.....	29	Pickups & Vans.....	25
Four-Wheel Drives.....	25	Plumbers.....	17
Furniture & Appliances.....	26	Professional.....	10
Garage Sales.....	1-2	Real Estate.....	31
Gardening.....	18-20	Recreational Vehicles.....	24
Going Out.....	11	Services.....	13-15
Hay & Feed.....	29	Sporting & Outdoors.....	26
Health & Fitness.....	23	Storage Space.....	31
Heavy Equipment.....	22-23	Tools & Building.....	13
Horses & Tack.....	29	Utility Trailers.....	25
Housekeeping/Carpets.....	14	Vacations.....	25
		Wanted.....	32

### Nickel's Worth Publishing

Heather Eller, *editor & publisher*

Emily Steigers, *production manager / designer*

Teresa Stanley, *bookkeeper*

Melanie Savage, *classifieds supervisor*

Kristin Klestinez, *ad taker*

Monica Thomas, *articles / ad taker*

Naidene Boer, *distribution supervisor*

208-667-0651 • [www.nickelsworth.com](http://www.nickelsworth.com)

The Nickel's Worth publishes weekly, new issues out every Thursday. Ads are due Wednesday at 3pm.

Office open Mon.-Thurs., 8am-5pm • Fri. 8am-3pm

**SPOKANE VALLEY HUGE** Moving Sale! Vietnam-era military gear, vintage and modern tools, yard equipment, tool cabinets, vintage reels and lures, antlers, biking, furniture, wall hangings, vintage glassware and more! 8am-4pm, Friday-Saturday, 5/15-5/16, 11007 E. Rockwell Ave.

**BAYVIEW GARAGE SALE**, Saturday, 5/23, in the Bayview Community Sale, 34070 Corbin. Bring your RV and make it a special getaway weekend. We book for the summer months; lakeview, creek, outdoor relaxing deck, 1 block from boat launch. Cell 208-449-7399 or voice message 208-683-7018



**More than a fabric store**

Family owned and operated

  
FABRIC

  
YARN

  
CLASSES

  
NOTIONS

296 W Sunset Ave, #14  
Coeur d'Alene, ID 83815

208.719.6549

[PINKTHREADIDAHO.COM](http://PINKTHREADIDAHO.COM)

**GOING CAMPING?**

EVERYTHING YOU NEED IS AT



**BLACK SHEEP SPORTING GOODS**

208-667-7831 • [BlackSheepIdaho.com](http://BlackSheepIdaho.com)  
In the Silver Lake Mall 200 W. Hanley, CDA, ID

**SURVIVAL & MEDICAL COURSES**  
UPCOMING DATES:

- July 25 & Aug. 8: All-Ages Intro to Wilderness Survival
- Sept. 18-20: Wilderness Survival Standard (Survival+WFA)
- Oct. 3-4: Essential Wilderness Survival



**ARTOS SURVIVAL**  
EMERGENCY MEDICINE AND OUTDOOR SURVIVAL

Northwest Montana  
406-885-1850 | [patrick@artosurvival.com](mailto:patrick@artosurvival.com)

15% off all courses until Sept. 30th with code NW2026

More info & sign up at [artosurvival.com](http://artosurvival.com)

Learn to be self-sufficient when help could be days away



**CAMERA CORRAL**  
DIGITAL PHOTO LAB

610 W Hubbard Ave  
STE 109  
Coeur d'Alene, ID 83814  
208-664-2420

*Your one stop camera shop!*



FILM PROCESSING  
ON SITE / NEXT DAY

*Film & Camera Sales  
Photos, Negatives, Slides  
Scanning & Printing*



- Putting in your spring garden? To keep your nails from developing a dirt problem, use this classic tip: Rake your nails over a bar of soap. It "seals" the gap underneath, and later when you wash your hands, the soap slips right out, no need to spend time scrubbing out the dirt!
- Add these to the list of items to eliminate the odor of cooking cabbage: a heel of bread, a whole walnut or a pinch of baking soda.
- Love beans but trying to save a little money? Don't be intimidated by dry beans. Just rinse them and chuck them in the slow cooker. Add water according to package directions and cook on low for up to eight hours. After they are cooled, you can bag them in zip-top bags and freeze them for easy use later.
- If you keep a couple of crackers in your sugar jar, they will keep the sugar from caking.
- If you or your kids have trouble drifting off to sleep, try this aromatherapy trick: Spray sheets with a diluted lavender essential oil. Lavender is classic for sleep time.
- "To make the most handy long handled garden tool, do this right now: Lay the tool on the ground (it can be a hoe, rake, whatever you use most) and, using a tape measure, mark out feet and inches with a permanent marker right on the handle. Now, when you go to put plants in the ground, you can space them out perfectly by laying down your tool along the planting line." -- C.O. in Arkansas

Send your tips to *Now Here's a Tip*, 628 Virginia Drive, Orlando, FL 32803.

**WE ARE OPEN!**

**EXIT 33**  
Yard **AND** Garden

**OVER 1000 ITEMS!**

The St. Regis Flea Market is Memorial Day weekend, come see us while you're in town!

St. Regis, MT • Hwy 135, behind the casino  
406-649-7008 • Find us on Facebook  
Open 10am-6pm, 7 days a week

## Miscellaneous

**BIG GARAGE SALE TREASURE HUNT!**

Hidden Gems & Unique Finds at Prairie Schooner Estates!

Come discover one-of-a-kind treasures • Handmade tables • Vintage guitars • Furniture • Collectibles • Clothes • Décor • Tools • **MORE!**

Sat. May 30th • 10am  
Prairie Schooner Estates  
2175 ID-53, Rathdrum  
*Rain or Shine!*

TUNE-UP AND REPAIR ON mowers and other power equipment. Reconditioned lawnmowers from \$180 and up. Accepting credit cards. 208-762-5651



YOU CALL, WE HAUL! WE specialize in clean-outs, junk removal, light demolition, yard debris removal and more; serving Kootenai County. Call IDAHAUL at 208-446-8054

FREE STRUCTURAL FILL dirt. Great for any project, just pay for delivery. Call 208-772-1883 for details

GARDEN TILLER, LARGE. Craftsman, 5HP, rear tines, counter rotation 7" tine, \$250. 208-671-4976



**SMOKE SHOP**  
Plummer, ID • 208-686-3270

**CHEAP SMOKES**  
Worley, ID • 208-686-3280

Winston \$88.00  
Signals \$32.10  
Smokin' Joe Naturals \$22.65  
Great Country \$25.50

**We have Geek Bars-15,000 puffs!**

QUEEN/ KING OAK headboard, \$25. Honda 6500 generator, water cooled, very low hours, \$1500. Free TV stand with heavy glass shelving, you load. 208-689-9796

SEE NICKEL'S Worth online: [www.nickelsworth.com](http://www.nickelsworth.com)

MINI 14, ATI STOCK, \$1100. Ithaca double barrel 12 gauge coach gun, \$300. Savage Enfield, in like new condition, \$400. 208-651-6609

RODENTS GOT YOU MAD? Rats/Riddo ridz you of pack rats and mice. Safe for pets, livestock or humans, \$16.95. Never see or smell them again! PO Box 330, Naples, ID 83847; 208-597-3031

BLACK SHEEP SPORTING Goods. Home of the lowest prices on all things outdoors. In the Silver Lake Mall, 200 W. Hanley, CdA. 208-667-7831; [www.BlackSheepIdaho.com](http://www.BlackSheepIdaho.com)



TWIN HEADBOARD, white, good condition, gently used, solid wood with all hardware included, made by Stanley Furniture Company, \$125. Carefully stored after a move with bubble and cling wraps to prevent any scuffs or dings. See additional pictures online at [nickelsworth.com](http://nickelsworth.com). Call or text 208-661-5771, Post Falls

AUSTRALIAN SHEPHERD tri color puppies. Males \$50, females \$100. OBO on all. 208-964-2508

COLLIGAN'S AUTO Service, 208-889-9547, 5250 E. Seltice Way, Post Falls. Colligan's Auto Service is now offering \$99 hourly shop rate for a limited time! Call for an appointment today!

WANTED: BIG PILES OF quality scrap iron, and metal salvage. Cash paid for most, we come and get it. On site dismantling available. 208-889-0968

TURNKEY CANDY Vending route for sale. Scalable income opportunity. Established candy vending business with significant growth potential. This is an ideal opportunity for an owner operator or investor looking for a low overhead, cash flowing business with room to expand. What's included: 300 Vendstar 3000 triple head candy vending machines; approx. 100 machines currently placed in active business locations with agreements in place; 200 additional machines in storage, ready to deploy into new locations. Highlights: existing route already generating income; proven placement agreements reduce start up friction; large inventory allows immediate expansion and revenue growth; simple product model with low maintenance and minimal labor requirements. This is a rare chance to acquire both an operating route and the inventory needed to scale quickly. Serious inquiries only. Contact Larry at 208-818-4498 for more details

To have *no fear of tomorrow*, ask *Jesus* to come into your life and he will take care of it

Paid for by RLW



**5TH ST FARMERS MARKET**  
DOWNTOWN COEUR D'ALENE

**WEDNESDAYS 4PM - 7PM**  
MAY 27 - SEPTEMBER 2

FREE MARKET TOTE OPENING DAY  
SPONSORED BY **ICCU**

5TH & SHERMAN | DOWNTOWN CDA

SHOP | STAY | PLAY  
CDADOWNTOWN.COM | 208.415.0116

IDAHO [visitidaho.org](http://visitidaho.org)

**RV CARPORTS For Less**

**WORK ON YOUR VEHICLE RAIN OR SHINE!**

YOUR OWN COVERED WORKSPACE  
BUILT TO FIT YOUR NEEDS.

- PROTECT**  
Protect your vehicles, tools, and equipment from the elements.
- WORK COMFORTABLY**  
Enjoy a dry, covered space to work on projects year-round.
- BUILT STRONG**  
Heavy-duty steel construction built to last a lifetime.
- SAVE MORE**  
Get more value and protection for less.

✓ PERFECT FOR CAR LIFTS, PROJECTS & STORAGE!

Call Pete **208-627-8698**  
RV CARPORTS FOR LESS

SERVING | IDAHO • MONTANA • WASHINGTON • OREGON

# Miscellaneous

★★★  
**BEDFORD**  
 PRECINCT COMMITTEEMAN  
 CONSERVATIVE REPUBLICAN

HELLO NEIGHBORS, I'M Catherine Bedford, your Conservative Republican running for PC 413. My platform is to represent you to keep our shared Idaho values. Please vote Catherine Bedford May 19th! Paid for by Catherine Bedford

★★★  
**BLACKBURN**  
 PRECINCT COMMITTEEMAN  
 CONSERVATIVE REPUBLICAN

I'M ERIN BLACKBURN, running in Precinct 510- I've lived in this neighborhood for 23 years! I'm excited to represent our precinct, keep you informed, and be your true conservative voice! Paid for by Erin Blackburn

★★★  
**ROUNDS**  
 PRECINCT COMMITTEEMAN  
 CONSERVATIVE REPUBLICAN

RE-ELECT MEGAN Rounds, the Republican Precinct Committeeman for Precinct 517. If reelected, I will continue to promote open, grassroots Republican leadership. I ask for your vote on May 19th. Paid for by Megan Rounds

YOUR FRIENDLY LOCAL free classified paper since 1972: the Nickel's Worth

★★★  
**ODLAND**  
 PRECINCT COMMITTEEMAN  
 CONSERVATIVE REPUBLICAN

RE-ELECT JEFF ODLAND PC 209 to protect our way of life. A real conservative who loves our founding documents and what they reflect. Endorsements include Sheriff Norris, Senator Phil Hart. Paid for by Jeff Odland

★★★  
**GRADY**  
 PRECINCT COMMITTEEMAN  
 CONSERVATIVE REPUBLICAN

I'M MARRIED WITH Three wonderful boys. I want a world where boys and girls can be themselves and play, read, and live in safety and purity of heart. Paul Grady 502! Paid for by Paul Grady

★★★  
**ELOE**  
 PRECINCT COMMITTEEMAN  
 CONSERVATIVE REPUBLICAN

I'M DANIEL ELOE, working for you. Conservative Republican PC for Precinct 515. Continue supporting proven leadership, values, and community commitment. Your vote Counts May 19th. Paid for by Daniel Elo

★★★  
**WHITE**  
 PRECINCT COMMITTEEMAN  
 CONSERVATIVE REPUBLICAN

I'M SANDY WHITE, YOUR Republican Precinct 318 Committeeman in Hayden. My pro-life, faith-driven, family-first values align with yours. Please vote by May 19th. Learn more at Sandy4Hayden.com. Paid for by Sandy White

BECOME A PUBLISHED author. We want to read your book! Dorrance Publishing trusted since 1920. Consultation, production, promotion and distribution. Free author's guide 877-729-4998 or dorranceinfo.com/ads

★★★  
**WHITE**  
 PRECINCT COMMITTEEMAN  
 CONSERVATIVE REPUBLICAN

HELLO RATHDRUM Voters: If you live north of 53 between Church Rd. and Sturgeon, and you're a conservative- I'm no RINO- please reelect Mary White as your Republican Precinct Committeeman 305. Paid for by Mary White

★★★  
**GRANUM**  
 PRECINCT COMMITTEEMAN  
 CONSERVATIVE REPUBLICAN

I'M AVERY, YOUR current Republican committeeman fighting to keep Idaho red in 417. As a grassroots PC, I consistently advocate for your conservative Christian values in the Kootenai GOP. Elect Granum! Paid for by Avery Granum

**VOTE!** May 19th  
**ALLYSON KNAPP**  
 FOR ASSESSOR

**Community Support**  
 Support like this does not happen without people willing to stand beside you. The names below include just a few of the local business owners, friends, neighbors, and community leaders who are supporting Allyson Knapp for Assessor. We are grateful for each of them and proud to share their support with our community.

<b>John Beutler</b> Century 21	<b>Damon Darakjy</b> Rockford Bay	<b>Chad Oakland</b> Northwest Realty Group
<b>Hollie Ann Flansberg</b> Gem County Assessor	<b>Ben Browne</b> Master Mechanic	<b>Ryan McCarty</b> Hayden, ID
<b>Jill Smith</b> KC Chief Deputy	<b>Reba Grytness</b> Community Dev.	<b>Linda Baccino</b> Beyond Beauty
<b>Zack Jones</b> Z. Jones & Assoc.	<b>Mark Johnson</b> Office Manager	<b>Med Spa</b> Nick Leonard & Dani Lyden
<b>Dan English</b> Former County Clerk	<b>Justin &amp; Audra Hardy</b> Retired)	<b>Susan Weathers</b> CDA City Clerk (Retired)
<b>Robin Butterfield</b> Mapping Dept.	<b>Donna Browne</b> KC Commercial	<b>Ryan McCarty</b> Hayden, ID
<b>Assessor (retired)</b>	<b>Appraiser Retired</b>	

**Endorsements**

**ED MORSE CRE, MAI, CERTIFIED GENERAL APPRAISER**  
**MIKE MCDOWELL RETIRED KOOTENAI COUNTY ASSESSOR**  
**JEFF MORBECK FORMER CERTIFIED APPRAISER, RETIRED**  
**TERRY FISHER CERTIFIED RESIDENTIAL APPRAISER**  
 Paid for by the Committee to Elect Allyson Knapp, Susan Weathers, Treasurer

HOME BREAK-INS TAKE less than 60 seconds. Don't wait! Protect your family, home, assets now for as little as 70¢ day! 833-890-1262

★★★  
**RUTLEDGE**  
 PRECINCT COMMITTEEMAN  
 CONSERVATIVE REPUBLICAN

HI, I'M MICHAEL Rutledge, your conservative Republican running for Precinct 520 Committeeman. If you live in Riverview, Highland Dr., or Cougar Gulch, vote Rutledge on May 19th! Paid for by Michael Rutledge

MOBILEHELP AMERICA'S premier mobile medical alert system. Home or away. For safety and peace of mind. No long term contracts, free brochure! 888-489-3936

★★★  
**HARRIS**  
 PRECINCT COMMITTEEMAN  
 CONSERVATIVE REPUBLICAN

I'M YASMIN HARRIS, Your current PC in Precinct 314. I'm your neighbor, a wife and mother, fiscally and socially conservative. If our values align, please vote for me May 19th! Paid for by Yasmin Harris



**RATHDRUM AREA VOTERS:**  
**PLEASE VOTE FOR A CHANGE!**

The North Idaho Republicans have endorsed these 5 Rathdrum candidates for Precinct Committeeman in the Rathdrum area. Here they are and this is why we hope you will vote for us

**Tim Skubitz:** Tim is likely the most active community member in Rathdrum. Tim and his wife own the local McDonalds. They have raised over \$47,000 for the Lakeland School District over the years. He served on the Lakeland School Board and Chamber of Commerce for several years. He is on the Advisory Board of the Salvation Army for the Kroc Center. His heart is dedicated to the community!

**Will Havercroft:** Will was a longtime employee of the Lakeland School District. He was a teacher for 40+ years and Athletic Director for Lakeland High School. His wife Mary is on the NIC Board of trustees. His heart is for education.

**Vic Holmes:** Vic has always been an active citizen in Rathdrum. He was the mayor of the city for 16 years and dedicated his life to that job. He was on the Rathdrum governing board and many others for 20 years and is extremely knowledgeable about the city. His heart is for Rathdrum,

**Fritz Wiedenhoff:** Fritz grew up in Rathdrum. He is a Captain in the Northern Lakes Fire Department. He is a recipient of the Idaho Medal of Honor. In addition to his regular job, Fritz also teaches new first responders at NIC. His heart is in protecting our community.

**Duncan Bell:** Duncan has lived in Rathdrum since 1979. He spent most of his career as a pharmacist at Rathdrum Drug and Medicine Man Rathdrum serving the health needs of his friends. He has always been a dedicated community member and was President of the local Rotary Club in Rathdrum. He believes in the Rotary Motto—Service above Self. His heart is for his friends and neighbors.

**Please Vote May 19th!**  
 Paid for by Duncan Bell

**Informed Republican voters know their precinct #**

**Do you know yours**

Scan QR Code or go to [www.KootenaiFreedomCaucus.org](http://www.KootenaiFreedomCaucus.org)  
 Paid for by Kootenai County Republican Central Committee. John Howard, Treasurer.

# Miscellaneous

PORTABLE OXYGEN concentrator may be covered by Medicare! Reclaim independence and mobility with the compact design and long-lasting battery. Inogen One free info kit! 877-305-1535

TOP DOLLAR PAID FOR old vintage guitars! Gibson, Fender, Martin, Greesch, Rickenbacker, Epiphone, etc. 1930s to 1980s. Call 866-433-8277

NEED CASH QUICKLY? WE buy houses in any condition. Get a fair cash offer within 24 hours! Call today. Liz Buys Houses: 833-359-4707

INFLATION AT 40-YEAR highs. Interest rates are up. Credit cards, medical bills, car loans. Have \$10,000+ in debt? Call National Debt Relief to find out how to pay off your debt for much less than you owe! Free quote: 844-955-4930

DIRECTV STREAM. Carries the most local MLB games! Choice Package \$89.99 month for 12 months. Stream on 20 devices. HBO Max included for 3 months with Choice Package or higher. No contract or hidden fees! Restrictions apply. IVS 866-859-0405

Just Like Cats & Dogs by Dave T. Phipps



## A PATTERN WE CAN'T AFFORD.

**When KCRCC-backed officials fail, we all pay.**

This isn't bad luck. It isn't coincidence. It's a pattern — and it keeps costing North Idaho families, students, and taxpayers.

### EDUCATION · LAKELAND SCHOOLS

**KCRCC-backed trustees have thrown Lakeland into turmoil.**

They've cycled through superintendents and placed their newest hire on paid leave with no misconduct cited. 84 former staff, superintendents, and community members have signed a letter demanding they resign. Two levies have failed. Teachers, students, and families are paying the price.

### HIGHER EDUCATION · NORTH IDAHO COLLEGE

**KCRCC-backed trustees nearly cost us NIC.**

Their governance drove the college into a "show cause" accreditation sanction — risking thousands of students' degrees and tens of millions in public funding. Taxpayers footed the bill for legal fees, reviews, and turnover. Voters rejected those trustees in November 2024.

### LIBRARIES · COMMUNITY LIBRARY NETWORK

**KCRCC-backed trustees cut services, then spent anyway.**

In 2023, the KCRCC-backed board cut hours, closed libraries on Sundays, and slashed programs despite public opposition. In 2024, 13 staff were laid off — all justified by refusing the routine 3% tax increase. Yet in 2026, the board took the 3% increase anyway, then approved a \$32,000 raise for the library director and a \$127,901 office lease. After years of cuts and layoffs, taxpayers deserve to ask: whose interests were really being protected?

Change Starts Here  
**Start with Your PC.**

Precinct Committeemen elect KCRCC leadership. If you want a KCRCC that puts community first, shares honest candidate information with voters, and is responsive to the people — vote for PCs who will make that change.

*Three institutions. One source. Real costs.*

**North Idaho Deserves Better.**

★ VOTE ★

**MAY 19 · REPUBLICAN PRIMARY**

— Paid by North Idaho Republicans —

★★★  
**BATESON**  
PRECINCT COMMITTEEMAN  
CONSERVATIVE REPUBLICAN

I'M TAMARA BATESON, your Christian, conservative Republican for Precinct Committeemen in 313. Please vote for me to continue to fight for true conservative values! Vote May 19th! Paid for by Tamara Bateson

★★★  
**HOWARD**  
PRECINCT COMMITTEEMAN  
CONSERVATIVE REPUBLICAN

VOTE MAY 19th! Jeannette Howard, Precinct 320 Committeeman. Keeping Kootenai County conservative. Defending parents' rights. Defending the 2nd Amendment. Endorsed and trusted by Rep. Vito Barbieri and Sheriff Norris. Paid for by Jeanette Howard

★★★  
**KOVACS**  
PRECINCT COMMITTEEMAN  
CONSERVATIVE REPUBLICAN

PRECINCT 412! BEST AVE. to Thomas Lane; 15th to Thomas Hill. No explicit content in schools or libraries; protect Idaho workers; pro-life. Vote Monica Kovacs— your neighborhood conservative advocate! Paid for by Monica Kovacs

★★★  
**BONNEY**  
PRECINCT COMMITTEEMAN  
CONSERVATIVE REPUBLICAN

PRECINCT 511 IS Greensferry to Spokane St., 4th to River. Support the Idaho Republican platform! Stand for the unborn and American citizens. North Idaho needs your vote for Carla Bonney. Paid for by Carla Bonney

★★★  
**MEYER**  
PRECINCT COMMITTEEMAN  
CONSERVATIVE REPUBLICAN

I'M AN INVENTOR, Professor and community representative on your school and soil/water district. My passion is my community. Please reelect Richard Meyer for Precinct 207 on May 19th! Paid for by Richard Meyer

★★★  
**DARAKJY**  
PRECINCT COMMITTEEMAN  
CONSERVATIVE REPUBLICAN

I'M AARON, WALKING with Tony Wisniewski, and with his confidence and your vote, hope to represent you as PC in 519. I will hold the line for faith, family and freedom. Paid for by Aaron Darakjy

★★★  
**LOKKEN**  
PRECINCT COMMITTEEMAN  
CONSERVATIVE REPUBLICAN

TOTAL CHAOS! OUR Precinct Committeeman, funded by that Joe Biden group, is protesting our trusted Republican sample ballot. Lock 'n load May 19th, vote Jeremy Lokken to restore Precinct 410! Paid for by Jeremy Lokken

★★★  
**SOMMER**  
PRECINCT COMMITTEEMAN  
CONSERVATIVE REPUBLICAN

RE-ELECT LUKE SOMMER for Precinct 310 Committeeman. Standing firm for conservative principles, transparency, and grassroots control— because our party should represent voters, not insiders. Paid for by Luke Sommer

★★★  
**ANDERSON**  
PRECINCT COMMITTEEMAN  
CONSERVATIVE REPUBLICAN

VOTE BRENDON Anderson to keep Idaho red and stop the steal! Legacy money and corporate interests are attempting to change the Republican Party. I will fight to conserve family values in 504! Paid for by Brendon Anderson

★★★  
**PLEW**  
PRECINCT COMMITTEEMAN  
CONSERVATIVE REPUBLICAN

MY COMMUNITY FOCUS brings my faith, family and work in Post Falls together to represent you. I bring unity, not division, to your local GOP. Vote Aaron Plew for Precinct 516! Paid for by Aaron Plew



# THE REAL ELECTION IS NOW THROUGH MAY 19

In North Idaho, the May primary most often determines who actually wins.

Turnout can be under 30%.

That means your vote counts more.

Grassroots means YOU!

**VOTE MAY 19**

Paid by North Idaho Republicans PAC

**SUPPORT KOOTENAI COUNTY FIRE & RESCUE**

- A TEMPORARY 2-YEAR LEVY
- NO permanent tax increase
- ★ PUBLIC SAFETY. ★ OUR COMMUNITY. ★ OUR PRIORITY. ★ PUBLIC SAFETY MATTERS ★

## REPUBLICANS YOU CAN COUNT ON

Every candidate North Idaho Republicans endorses has experience, integrity, and a commitment to Idaho values. **We only endorse those who meet the standards Idahoans deserve.**



**GOVERNOR**  
Brad Little



**LT GOVERNOR**  
Scott Bedke



**SECRETARY OF STATE**  
Phil McGrane



**TREASURER**  
Julie Ellsworth



**CONTROLLER**  
Brandon Woolf



**SUPT OF SCHOOLS**  
Debbie Critchfield



**DIST 1 SENATE**  
Jim Woodward



**HOUSE SEAT 1A**  
Mark Sauter



**HOUSE SEAT 1B**  
Chuck Lowman



**HOUSE SEAT 4B**  
Christa Hazel

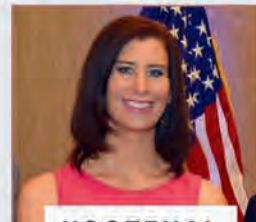

**KOOTENAI COUNTY CLERK**  
Jennifer Locke



**KOOTENAI COUNTY ASSESSOR**  
Allyson Knapp



**REPUBLICAN LEADERSHIP. NORTH IDAHO VALUES.**  
For more information visit [NorthIdahoRepublicans.org](http://NorthIdahoRepublicans.org)

We Are North Idaho **Republicans**. We are your neighbors. We believe in steady, conservative, principled leadership - rooted in common sense, accountability, & respect for the people - it's the Idaho way.



### OFFICIAL SAMPLE BALLOT

**Republican Precinct Committeeman • Primary Election 2026**

Kootenai County, Idaho • Vote for ONE candidate in your precinct

#### WHY YOUR PRECINCT COMMITTEE RACE MATTERS

- Precinct Committeemen (PCs) are your neighborhood voice in the Republican Party.
- They shape the direction of the party, share information on candidates and issues, and ensure local values are represented.
- When vacancies happen, PCs nominate candidates who may be appointed to fill legislative seats or county offices.

**TIP: When voting, start at the BOTTOM of your ballot and work your way up so you don't miss this critical race.**

- |                                              |                                             |                                                |
|----------------------------------------------|---------------------------------------------|------------------------------------------------|
| <input type="radio"/> P201 Colleen Attebury  | <input type="radio"/> P318 Nancy Jones      | <input type="radio"/> P415 Wendy Gabriel       |
| <input type="radio"/> P203 Jennifer Hammond  | <input type="radio"/> P319 John Young       | <input type="radio"/> P416 Dan Gookin          |
| <input type="radio"/> P204 Bob Thornton      | <input type="radio"/> P320 Aaron O'Brien    | <input type="radio"/> P417 Gabe Eckert         |
| <input type="radio"/> P207 Bev Twillman      | <input type="radio"/> P321 Charlie Specht   | <input type="radio"/> P418 Dan Sheckler        |
| <input type="radio"/> P209 Rebecca Hasz      | <input type="radio"/> P322 David Bobbitt    | <input type="radio"/> P419 John Goedde         |
| <input type="radio"/> P301 Tim Skubitz       | <input type="radio"/> P323 Annette Nolting  | <input type="radio"/> P420 Pete Erbland        |
| <input type="radio"/> P303 Lauren Traw       | <input type="radio"/> P401 Lacey Moen       | <input type="radio"/> P502 Tim Willig          |
| <input type="radio"/> P304 Pete Broschet     | <input type="radio"/> P403 Justin Schorzman | <input type="radio"/> P503 Scott Tollackson    |
| <input type="radio"/> P305 Duncan Bell       | <input type="radio"/> P404 Joshua Dahlstrom | <input type="radio"/> P504 Patrick O'Halloran  |
| <input type="radio"/> P306 Vic Holmes        | <input type="radio"/> P405 Marc Stewart     | <input type="radio"/> P508 Garrett Kreitz      |
| <input type="radio"/> P307 Friez Wiedenhoff  | <input type="radio"/> P406 Todd Tondee      | <input type="radio"/> P511 Paul Wagner         |
| <input type="radio"/> P308 Will Havercroft   | <input type="radio"/> P407 Mary Souza       | <input type="radio"/> P512 Neko Caballero      |
| <input type="radio"/> P311 Pierce Clegg      | <input type="radio"/> P408 Gary Neill       | <input type="radio"/> P514 Russell Mann        |
| <input type="radio"/> P312 Rob Harding       | <input type="radio"/> P409 Dave Raglin      | <input type="radio"/> P515 Jon Gardunia        |
| <input type="radio"/> P313 Dan Green         | <input type="radio"/> P410 Sid Smith        | <input type="radio"/> P516 Dan Redline         |
| <input type="radio"/> P314 Kellie Palm       | <input type="radio"/> P411 Randy Neal       | <input type="radio"/> P517 Chris Cheeley       |
| <input type="radio"/> P315 Bill Deruyter     | <input type="radio"/> P412 Vanessa Moos     | <input type="radio"/> P519 Donald Ashenbrenner |
| <input type="radio"/> P316 Chris Beaty       | <input type="radio"/> P413 Glenn Avery      | <input type="radio"/> P520 Jason Nye           |
| <input type="radio"/> P317 Charlene Matheson | <input type="radio"/> P414 Katie Schreiber  | <input type="radio"/> P521 Jim Barton          |



RATED  
VETTED  
REPUBLICAN

VOTE MAY 19  
OFFICIAL KCRCC  
RECOMMENDED

**US SENATOR**

JIM RISCH

**U.S. REPRESENTATIVE DISTRICT 1**

RUSS FULCHER

**GOVERNOR**

MARK FITZPATRICK

**STATE CONTROLLER**

BRANDON WOOLF

**STATE TREASURER**

JULIE ELLSWORTH

**ATTORNEY GENERAL**

RAUL LABRADOR

**IDAHO STATE SENATE SEAT FOR LD1**

SCOTT HERNDON

**IDAHO STATE REPRESENTATIVE SEAT 1A**

JANE SAUTER

**IDAHO STATE REPRESENTATIVE SEAT 1B**

CORNEL RASOR

**IDAHO STATE SENATE SEAT FOR LD2**

PHIL HART

**IDAHO STATE REPRESENTATIVE SEAT 2A**

HEATHER SCOTT

**IDAHO STATE REPRESENTATIVE SEAT 2B**

DALE HAWKINS

**IDAHO STATE SENATE SEAT FOR LD3**

DOUG OKUNIEWICZ

**IDAHO STATE REPRESENTATIVE SEAT 3A**

VITO BARBIERI

**IDAHO STATE REPRESENTATIVE SEAT 3B**

JORDAN REDMAN

**IDAHO STATE SENATE SEAT FOR LD4**

BEN TOEWS

**IDAHO STATE REPRESENTATIVE SEAT 4A**

JOE ALFIERI

**IDAHO STATE REPRESENTATIVE SEAT 4B**

ELAINE PRICE

**IDAHO STATE SENATE SEAT FOR LD5**

CARL BJERKE

**IDAHO STATE REPRESENTATIVE SEAT 5A**

RON MENDIVE

**IDAHO STATE REPRESENTATIVE SEAT 5B**

TONY WISNIEWSKI

**COUNTY-SPECIFIC**

**KOOTENAI COUNTY COMMISSIONER DIST 1**

JULIE HENSLEY

**KOOTENAI COUNTY COMMISSIONER DIST 2**

BRUCE MATTARE

**KOOTENAI COUNTY CORONER**

DUKE JOHNSON

**KOOTENAI COUNTY TREASURER**

CARLOS ZAMORA

**KOOTENAI COUNTY CLERK**

JENNIFER LOCKE

**KOOTENAI COUNTY FIRE / RESCUE LEVY**

YES

Please be advised that NOT ALL candidates or measures will be on EVERY ballot. *Candidates and measures will appear on your ballot depending upon where you live.*

Candidates running UNOPPOSED will still appear on your ballot. Only candidates and measures supported by the KCRCC are shown here.

**Be an INFORMED VOTER**

See our signature Rating and Vetting Program at [KCRCC.COM](http://KCRCC.COM).

Read Candidate questionnaires and our objective Voter Guide



<https://www.kootenaigop.org/voter-guide>

**DON'T BE FOOLED**  
*The KCRCC is your ONLY local*  
**OFFICIAL Republican Party**

fidelis optimatum principis

# Miscellaneous

DENTAL INSURANCE from Physicians Mutual Insurance Company. 400+ procedures. Real dental insurance, not a discount plan. Free info kit! 855-526-1060 www.dental50plus.com/ads #6258

HAVE AN EVENT YOU'D like to add to our Community Calendar? Please send information to articles@nickelsworth.com

PROFESSIONAL LAWN service: Fertilization, weed control, seeding, aeration and mosquito control. Free quote. Ask about first application special! 833-860-0811

BATH AND SHOWER updates in as little as 1 day! Affordable prices. No payments for 18 months! Lifetime warranty and professional installs. Senior and military discounts available. 1-877-543-9189

BIG, SMALL, YOU'LL FIND it all in the Nickel's Worth

DON'T LET THE STAIRS limit your mobility! Discover the solution for anyone who struggles on the stairs, concerned about a fall or wants to regain access to their entire home. AmeriGlide 833-399-3595

★★★  
**GUENETTE**  
 PRECINCT COMMITTEEMAN  
 CONSERVATIVE REPUBLICAN

I'M BEVERLY GUENETTE, your neighborhood Republican volunteer in 406. If you want an advocate for your Conservative values in the grassroots Republican party, please elect me as Precinct Committeeman! Paid for by Beverly Guenette

★★★  
**ADAMS**  
 PRECINCT COMMITTEEMAN  
 CONSERVATIVE REPUBLICAN

I'M STEVE ADAMS, candidate for Republican Precinct Committeeman in 405. I will be your voice for true Christian, conservative, Republican principles. Vote Steve Adams on May 19th. Paid for by Steve Adams

★★★  
**WILLIAMS**  
 PRECINCT COMMITTEEMAN  
 CONSERVATIVE REPUBLICAN

PRECINCT 401 NEEDS A Committeeman who will advocate for your conservative values and hold the line against the loud minority. Stand with Joseph Williams to stand with you. Paid for by Joseph Williams

★★★  
**STOLTZ**  
 PRECINCT COMMITTEEMAN  
 CONSERVATIVE REPUBLICAN

I'M DAVID STOLTZ, YOUR neighborhood Republican PC in 503. If you're in Post Falls between Prairie and Poleline, Chase and McGuire, I'm your huckleberry. If you like what I'm doing, vote! Paid for by David Stoltz



★★★  
**COOKE**  
 PRECINCT COMMITTEEMAN  
 CONSERVATIVE REPUBLICAN

DOWNTOWN CDA NEEDS a strong, common sense voice to protect what makes Cda great. Let's steward what we have to benefit our kids and grandkids. Vote Jim Cooke for Committeeman 416. Paid for by Jim Cooke

★★★  
**BARLOW**  
 PRECINCT COMMITTEEMAN  
 CONSERVATIVE REPUBLICAN

HI! I'M JERRY BARLOW, running for reelection as PC 411. I'm your true conservative representative, working to keep you informed. Make your vote count! Together we will keep Idaho red! Paid for by Jerry Barlow

★★★  
**HANDEEN**  
 PRECINCT COMMITTEEMAN  
 CONSERVATIVE REPUBLICAN

I'M YOUR CURRENT PC in 414 and Region 2 Chairman for Idaho GOP, deeply involved in policy groups to maintain the conservative character of Idaho. Re-elect Bjorn Handeen! Paid for by Bjorn Handeen

★★★  
**FISHER**  
 PRECINCT COMMITTEEMAN  
 CONSERVATIVE REPUBLICAN

I'M A YOUTH COACH, technology professional and business owner, working to preserve the innocence of our kids and the character of our community in precinct 404. Joe Fisher for PC! Paid for by Joe Fisher

★★★  
**THOMPSON**  
 PRECINCT COMMITTEEMAN  
 CONSERVATIVE REPUBLICAN

I'M PHIL, A FORMER PC and GOP delegate, picking back up for Tonya in our Precinct 306 to hold our conservative position in the KCRCC. Looking forward to representing you again! Paid for by Phil Thompson

★★★  
**WENTZEL**  
 PRECINCT COMMITTEEMAN  
 CONSERVATIVE REPUBLICAN

I'M CONRAD, A BLUE collar electrician but I live red. Long time volunteer, youth event organizer, looking to help preserve our conservative Idaho community. I stand for honesty in 312. Paid for by Conrad Wentzel

★★★  
**LA LIBERTE**  
 PRECINCT COMMITTEEMAN  
 CONSERVATIVE REPUBLICAN

STOP THE DIVISIVENESS from the Not Into Republicans (NIR) chaos group, Bring sanity back to the Kootenai GOP. If you're conservative, I am on your team! Vote Terry LaLiberte, PC 301. Paid for by Terry LaLiberte

★★★  
**KUHNS**  
 PRECINCT COMMITTEEMAN  
 CONSERVATIVE REPUBLICAN

30 YEAR RESIDENT OF Kootenai County, married 47 years to a third generation Idahoan, Howard stands for sanctity of life, traditional marriage and family, secure borders, minimal government, in Precinct 415. Paid for by Howard Kuhns



## Has YOUR Polling Place CHANGED?

To confirm your location, go to:

[www.kootenafreedomcaucus.org](http://www.kootenafreedomcaucus.org)

or scan here



**KCRCC**



**North Idaho Republicans PAC**

**Official Status?**

**OFFICIAL**  
 Republican Party of Kootenai County Recognized by Idaho GOP & law



**NOT OFFICIAL**  
 No charter from Idaho GOP

**Meetings?**

**Every 4th Tuesday**  
**Public welcome!**



Closed

**Joining?**

**Run for precinct rep every 2 years.**  
**74 elected precinct reps.**



Secret

**Candidate Selection?**

**Public questionnaire.**  
**Members vote.**  
**Results posted.**



Obscure

**Funding?**

**Public donations & Lincoln Day Dinner**



**Dark money & shady PACs**

**Two Republican Groups.**

**Only One Is Official & Transparent.**

★ ★ ★  
**STAVISH**  
 PRECINCT COMMITTEEMAN  
 CONSERVATIVE REPUBLICAN

MIKE STAVISH FOR Precinct Committeeman 319. Stop the NIR takeover, misleading voters, ranked choice voting, pro-abortion alignment. 30+ year conservative Republican. Real representation. 208-660-7774 or mikestavish.com. Vote Stavish. Paid for by Mike Stavish

★ ★ ★  
**BURGESS**  
 PRECINCT COMMITTEEMAN  
 CONSERVATIVE REPUBLICAN

MICHAEL BURGESS FOR Precinct 514 Committeeman. Born in Spokane. Raised in Opportunity. Matured in Montana. Polished in Post Falls. Defending our rights to fulfill duties to God, family and neighbor. Paid for by Michael Burgess



**Sunset Over Hayden**  
 Photo by Dan Thomas

★ ★ ★  
**DOUGHERTY**  
 PRECINCT COMMITTEEMAN  
 CONSERVATIVE REPUBLICAN

I'M BILL DOUGHERTY, your neighborhood Republican business owner, trusted CPA and family man fighting your conservative values and to preserve our community for my grandchildren and yours in Precinct 321. Paid for by Bill Dougherty

★ ★ ★  
**ROMAN**  
 PRECINCT COMMITTEEMAN  
 CONSERVATIVE REPUBLICAN

HELLO! I'M JOCELYN Roman, your Republican Candidate for PC in 308, our Rathdrum neighborhood. My focus is to maintain and enhance conservative values. Please vote for me on May 19th! Paid for by Jocelyn Roman

★ ★ ★  
**FANSLER**  
 PRECINCT COMMITTEEMAN  
 CONSERVATIVE REPUBLICAN

MICHELLE FANSLER IS your neighborhood Republican PC candidate in 509. If you want an advocate for your Conservative values of faith, family and freedom in the Republican party, vote Fansler! Paid for by Michelle Fansler

★ ★ ★  
**FAY**  
 PRECINCT COMMITTEEMAN  
 CONSERVATIVE REPUBLICAN

I'M DANA FAY, ACTIVE IN Idaho Young Republicans, campaign volunteering for national and local candidates. As a customer service professional, I will represent our Precinct 418 neighborhood well in KCRCC. Paid for by Dana Fay

★ ★ ★  
**LOFFMAN**  
 PRECINCT COMMITTEEMAN  
 CONSERVATIVE REPUBLICAN

FOR 20+ YEARS, I'VE owned and operated an award-winning property management company. My success comes from hard work, solving problems and relationships. Vote Debbie Loffman for Precinct 403! Paid for by Debbie Loffman

★ ★ ★  
**JOSTLEIN**  
 PRECINCT COMMITTEEMAN  
 CONSERVATIVE REPUBLICAN

I'M WILHELM JOSTLEIN, your neighborhood Republican volunteer distributing election material to your door in 419. Once PC, I will advocate for your conservative values in the GOP. Vote May 19th! Paid for by Wilhelm Jostlein

★ ★ ★  
**TROUETTE**  
 PRECINCT COMMITTEEMAN  
 CONSERVATIVE REPUBLICAN

I WORK TO PRESERVE your hunting/ fishing experience, youth community, and business security. Let me continue to work to preserve your freedoms as your current Precinct 316 Committeeman. Vote Paul Trouette! Paid for by Paul Trouette

★ ★ ★  
**BARNETT**  
 PRECINCT COMMITTEEMAN  
 CONSERVATIVE REPUBLICAN

I'M A RED-BLOODED Republican, Pachyderm president, past GOP delegate, outreach coordinator, and Safe Start director. Bringing my volunteer energy to represent you in Precinct 315. Vote Nicole Barnett PC! Paid for by Nicole Barnett

## Miscellaneous

SNOW/ GRADING BLADE, Craftsman, 42", for front of garden tractor, model 486244412, works well, \$100. 208-671-4976

PEACE OF MIND AND early detection. Now more than ever, it's important to get screened for stroke and cardiovascular disease risk. Life Line Screening is simple and painless. 833-970-4172

PEST CONTROL: PROTECT your home from pests safely. Roaches, bed bugs, rodent, termite, spiders and more. Locally owned and affordable. For service or inspection today! 833-860-0657. Have zip code ready!

WANT TO BUY decorative, wall hanging old guns, any condition acceptable. Please call Spirit Lake, ID, 406-581-2770, RAD Finds

PREPARE FOR POWER outages today. Generac Home Standby Generator. Receive free 5 year warranty with qualifying purchase. 855-948-6176 to schedule free quote. It's not just a generator. It's a power move

IT'S A TRAP, A BAIT AND switch tactic to prepare people into taking the Mark of the Beast (Sunday worship services), which will result in suffering the horrors of the 7 last plagues. President Trump made an executive order on May 4th that all Americans are to honor May 16th to honor the 7th sabbath (Saturday). The agenda is to truck the Christian world into demanding a day for themselves: Sunday. Because Trump places honor on the so-called Jewish Saturday issue, this tricks the so-called Christian world into also demanding a day for themselves, which they call the Lord's Day, Sunday, thereby getting people to take the Mark of the Beast. Had they bothered to study the Bible, they would have realized that God calls the 7th day sabbath, Saturday, the Lord's Day (Isaiah 58:13, 14 and Matthew 12:8). God blessed only one day of the week as holy (Genesis 2:1-3), and as a sign of loyalty towards Himself (Ezekiel 20:12, 20). God promises a blessing to anyone who observes the 7th day sabbath (Saturday), and the word sabbath means a day to rest from all work (Exodus 20:8-11). Tim, 208-217-8942 text

THE GREATEST COVERUP of all time. How the Father and son's personal names were hidden. Prov 30:4 "What is His name, and what is His son's name if you can tell." Write: YHWH, PO Box 306, Libby, MT 59923

JACUZZI BATH REMODEL can install a new, custom bath or shower in as little as 1 day. Limited time, waving all installation costs! Additional terms apply. Subject to change and vary by dealer. Ends soon. 844-501-3208

WANTED: BIG PILES OF quality scrap iron, and metal salvage. Cash paid for most, we come and get it. On site dismantling available. 208-889-0968

MOVING SALE OUT OF Moyie Springs. 208-507-1211

ATTENTION: RAISED BED gardeners. Don't use treated lumber full of toxic chemicals. I have all natural heartwood western red cedar boards, full dimension. 2x10, any length, \$10 per lineal foot; 2x12, any length, \$12 per lineal foot. Call Nelson at 208-215-9661

AGING ROOF? NEW homeowner? Storm damage? You need a local expert provider that proudly stands behind their work. Fast, free estimate. Financing available. 833-640-4753. Have zip code ready when calling!

CONSUMER CELLULAR, same reliable, nationwide coverage as large carriers. No long-term contract or hidden fees, free activation. All plans unlimited talk and text starting at just \$20 month. 877-751-0866

REACH MILLIONS OF homes nationwide with one easy, affordable buy in the ADS Network! For more information www.communitypublishers.com/category/all-products

WATER DAMAGE cleanup and restoration: A small amount of water can lead to major damage in your home. Our trusted professionals do repairs to protect your family and home value! 833-887-0117. Have zip code ready!

WESLEY FINANCIAL Group, LLC timeshare cancellation experts over \$50 million timeshare debt/ fees cancelled in 2019. Free info package. Free consultations. Over 450 positive reviews. 833-308-1971



**Bryan Stark**  
 Sales Specialist - Personal Lines  
 8606 N. Wall St., Ste. 103  
 Spokane, WA 99218  
 (509) 822-3941  
 bstark@amfam.com



**Smith & Associates LLC**

## Miscellaneous

**COUNTRY BOY COINS**  
 COINS, BULLION, GOLD, & SILVER  
 MORGAN & PEACE DOLLARS AND COLLECTIONS

**BUY** 91 W. Commerce Dr., Hayden, ID **SELL**  
 Call for appointment: 208-640-4180

CDA YARD SALE! 7am-4pm Friday-Saturday, 5/15-5/16, 3380 W. Parda Dr. Assorted military and hunting gear, 280 caliber rifle with ammunition, gas edgers, china set, vintage Harley tank and assorted household goods. It all needs to go!

NATIONAL SUNDAY LAW? God never forces our will! Legislated worship is not of God. Call 509-233-8155 for free information (book)

A BIG MISTAKE PEOPLE make about Christianity is thinking they have to change themselves before Jesus will accept them. When Jesus said that a person must be born again to get into the kingdom of God, it's just that, because absolutely no one comes into Christianity knowing everything there is about it. It is a growing up process, as a baby learns to walk before they can run. That is why God says not to judge anyone, because you can't know what stage of growth they are at, at that moment. The all important point is: to start, be willing to learn, don't try to change yourself, as God takes care of that Himself, simply through Bible study, and that is why I always encourage Bible study before going to any church. The Bible clearly points out that the born-again experience is only through the word of God, the Bible (1 Peter 1:23). The Bible is like a jigsaw puzzle, you just have to put all the pieces together, in the right order, to get the whole picture, and that takes time, don't rush it. If you need help, I provide whatever help you want, on any Bible subject you're interested in, by referring you to Bible verses you can read for yourself, on any given subject, so you can make up your own mind on what you want to believe. (Remember that the Bible can be read free online.) Tim, 208-217-8942, text

**TK AUTO Sales**  
 509-242-3588  
 tkautosalespokane.com  
 6904 E. Sprague  
 Spokane Valley, WA  
**FINANCING AVAILABLE OVER 275 VEHICLES IN STOCK**

BLUE PILLS AS GENERIC viagra, 10 tablets for only \$25. Money back guarantee. Call 608-717-6145, pmtravel2009@yahoo.com

ELECTRICIAN TO SERVE. Customer service is our specialty. By the hour or we will bid. License number 21938. 208-771-1253

2016 FLAGSTAFF BY Forest River Shamrock M-183 hybrid, super clean, 1/2-ton towable. JD Power average retail value \$11,250. Being offered for auction at Post Falls Auto Auction, 1094 N. McGuire Rd., Post Falls, Idaho 83854 on 05/16/2026. Call 208-457-3091

VORTEX SPOTTING Scope, 20x60x85 HD, \$800; Vortex Kaibab Binos, 18x56, \$600; Swarovski 10x42 EL, \$1700. All have the lifetime warranty. Garmin inReach Mini 2, \$275. Pictures online at www.nickelsworth.com. Call or text 602-618-6849, Post Falls

LINCOLN RANGER 305G 10kW portable welder generator, runs good, \$4250. Lincoln Weld-Pak wire feed welder, \$280. Honda EB6500 generator, works great, \$2850. Honda EU2000i inverter generator, \$780. Generac IX 2000 inverter, \$550. Craftsman 42" lawn tractor, runs good, \$850. 6x10 steel trailer with side rails and loading gate, \$2350. 1988 Honda Elite 50 scooter, parts bike, \$600. Credit cards accepted, 208-762-5651



**HICO Convenience Center**

15963 N. Hwy 41 Rathdrum, ID  
**AND**  
 Ross Point Hico  
 770 N. Hwy. 41 Post Falls, ID

NOW CARRYING  
**Ethanol-Free Premium**

**ADULT WAREHOUSE** *Your pleasure is our business*

**We carry everything you desire to spice up your love life**

3355 E. Trent Ave., Spokane 509-534-5494

## Auctions & Miscellaneous



VAN VALKENBURG Estate Auction, Saturday, May 16th, 9am. 280 McMannamy Draw, Kalispell, MT. Live/ online bidding on select items starts at 10:30am. Vehicles/ equipment/ trailers/ parts: 1967 Chevy Impala; 1995 Ford F350 XLT crew cab truck, manual, 4x4, runs; 1971 GMC Special motorhome/ bus, runs; 1968 Ford F100 truck; 1979 Jeep with lots of extra parts; 1988 Randy Travis tour bus, needs motor; 1996 Featherlite 48 aluminum cargo trailer car hauler, 8' enclosed, triple axle, generator, viewing platform, interior lights, air compressor, in-floor winch, power up/down ramp; 1973 speed boat with trailer; 1977 speed boat with trailer; 1987 Peterbilt dump truck, Cat motor, tag axle, 15' bed; 1993 Reliance transfer trailer, 15', parts; 1999 Reliance transfer trailer, 15'; 2004 Peterbilt sleeper, 11' aluminum bed, gooseneck hitch, cylinder blown in motor; 1981 Kenworth dump truck, Detroit diesel, 11R-24.5 tires, 14' bed, Eaton transmission, 672K+/- miles; 1973 boom truck W923 with National Crane 6T-56 boom, 18' bed, Cummins diesel; 1979 Fruehauf belly dump trailer BD8?; 1982 Ravens flatbed trailer, 45' aluminum semi, 10' spread axle, (2) 5' under-bed boxes; 2002 tilt top trailer; 1996 lowboy trailer, Beau 38', drop tail, 50 ton; 1993 trash trailer 30'; 1995 Featherlite aluminum trailer open deck, 8'x49', triple axle, 8' under-deck storage; 1967 Volkswagen Bug plus 3 more and new motor; 1974 Ford F250 truck, manual 4x4, Ranger; 1975 Ford F250 Ranger XLT truck, manual, 4x4, currently running; Truckweld dump pup trailer 13' with 20' adjustable tongue; 1993 Ford F150 XLT regular cab 4x4 truck, 8' bed, manual (parts truck); Cat motor grader 8T1148, 12' blade; Cat motor grader 8T2623, no blade; CAT motor grader 9K2592SP; 2000 Freightliner with sleeper, RigMaster Perkins auxiliary motor, no title,

*continued from prev. column*

no 5th wheel; 12' aluminum deck flatbed trailer; sheepherder wagon top with stove and runners; TrailMax T-16 20' trailer, 16' tilt, 4' stationary; Pepsi cooler trailer 8'; golf carts (3); Oshkosh truck; fire truck; rat rod; Ford plow truck; trailer/ Snowcat; Genie S-40 man lift, gas, turns over; TransAm Bandit car; El Camino; Camaro; Volkswagen motor, new; semi tires; semi hoods; semi tanks; pallet of restaurant equipment, (2) empty containers; (19) semi cabs semi sleeper; (2) diesel motors, Cummins N14, both run; antique fridge; misc. furniture; Harley; (3) scrap cars; old blue box trailer on wheels; yellow Chevy; Chevy Impala; Mustang cars, parts; post lift; 1993 Chevrolet truck, manual 4x4, 9' flatbed, GN hitch; TrailMax TD-40T, tandem axle, dually equipment trailer, tiltbed; storage truck boxes 18' and 22', buyer loads. Shop/ tools: Jet belt sander/ disc grinder; Blue-Point transmission jack 1/2 ton; welding cart 2 tanks; swamp cooler general; Safety Sheen tub for cleaning tools, 5-6 tool totes; 8 misc. bolt buckets; 4 paint totes, guns, sprayer, sandpaper paint paper cart; 4 small bottle jacks; big bottle jacks; propane tanks, torch, heaters; engine blocks; 2 grease containers; Jet sanding/ buffer; small portable sand blaster; Miller 250 Syncrowave welder; Jet band saw; antique plates; antique magazines; 2 floor jacks; 5 bolt bins; drawers; tote Snap-On tools; 3 engine stands; 6' ladder; book shelf; motorcycle ramp; box of straps; sheetrock jack; Monarch wood cook stove; road and construction signs; log bed, furniture; horse tack; tire chains, several; hotel light fixtures; 15 neon beer lights; chains, binders; log truck bunks; glass patio tables; Millermatic 211 welder; Skat Blast sand blaster; auto body work stands; Griswold #8 Dutch oven; hames and collars; mirror, tables; scaffold and planks; pallets of semi and car parts; Rigid pipe vise; Club 13 Bar street sign; Oasis Bar street sign. So much more! Inventory may vary by sale day. See website for photos and inventory: [www.KevinHillAuctions.com](http://www.KevinHillAuctions.com)

*continued in next column*

**WHEELS** On the car... or on their own

You'll find them in the Nickel's Worth



Photo by Victoria Peterson

Professional

NORTH IDAHO DENTURES & IMPLANTS

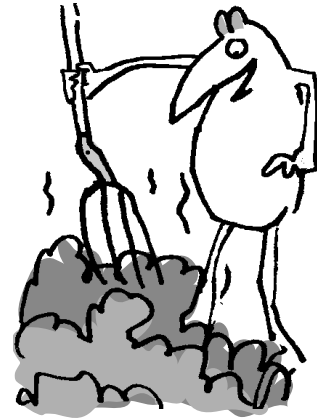

HERE AT NORTH IDAHO Dentures & Implants, we offer full-service denture and implant services at competitive prices. We specialize in full mouth restoration, extraction, and implant procedures to include bone and tissue regeneration for your long-term benefit. We use only the highest quality products and materials. Give us a call now to schedule your free consultation with Dr. Olaru, 208-714-6845; [NorthIdahoDenturesandImplants.com](http://NorthIdahoDenturesandImplants.com)

# ZIGGY'S SELLS POLE BUILDINGS

INSTALLED or in DO-IT-YOURSELF KITS!



GO TO [www.ziggys.com/polebuilding](http://www.ziggys.com/polebuilding)



170 W. WYOMING AVE. • HAYDEN, ID.

(208) 772-9511

2121 N. HIGHWAY 41 • POST FALLS, ID.

(208) 777-1955

[www.ziggys.com](http://www.ziggys.com)

(ID RCE 10614) (WA CC01 ZIEGLL #316JG)



**100% Creston Valley Fruit • Natural Colours & Flavours • Grain & Nut Free**  
**sternwheeler.ca 250-428-1764 Creston, BC**  
**Just a hop, skip & a jump across the border!**  
 Mon-Tues: 12-7 • Wed-Fri: 12-8 • Sat: 11-8 • Sun: 11-6  
 Open Mic every other Friday, 9pm  
 Creston Cruisers Show & Shine Wed., 6pm-dusk  
 Open later by appt. for your special events, call for info!

**R.F.D.**

by Mike Marland

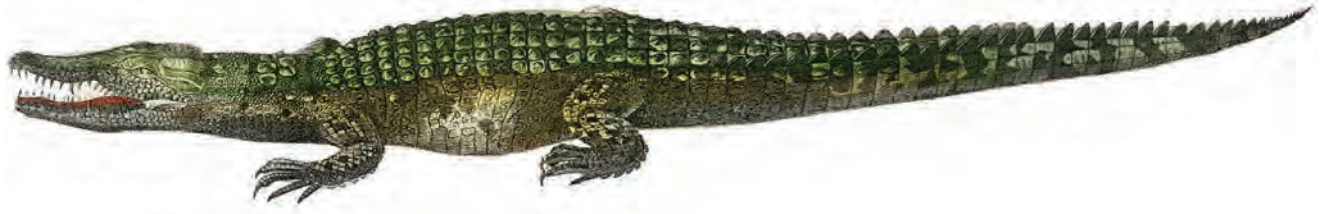
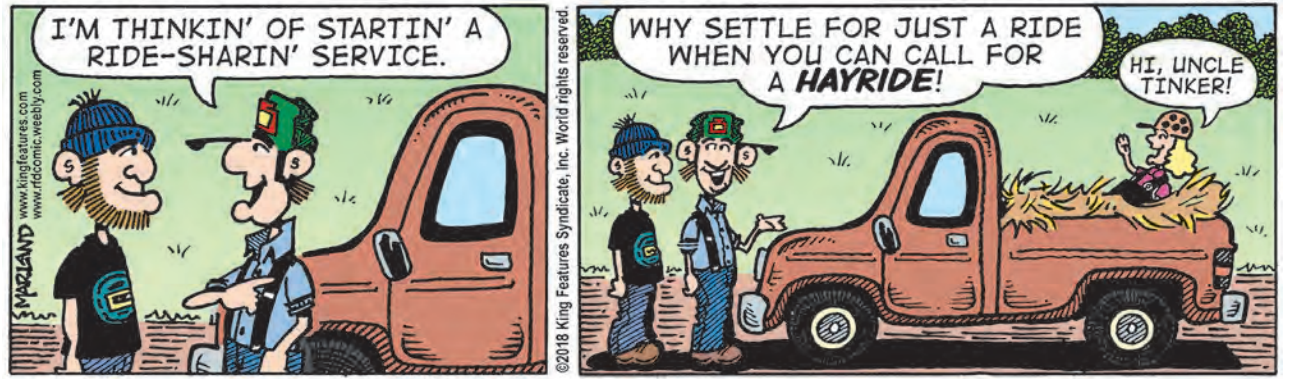

**Going Out**



**WALK-IN SMALL PLATES** at Candle in the Woods. Every Thursday, 2pm-8pm, no reservations needed. Order à la carte appetizers, featuring a new menu every month! Perfect for a friends' get-together or a romantic date. 5751 ID-54 in Athol, ID. Or to reserve a seat for our full 12-course dining experience visit: [www.thecandleinthewoods.com](http://www.thecandleinthewoods.com)

**WORK LATE? NICKEL'S** Worth has a front-door mail drop, 107 N. 5th St., CdA



**STIR FRY GUYS** IN CDA serves fast, fresh, and customizable stir fry bowls packed with premium ingredients and bold flavors, all made to order at the Prairie Pavilion, 7777 N. Heartland Dr., CdA, 83815. We're open 11-ish-4pm Monday, and 11-ish-7pm Tuesday through Friday, with DoorDash delivery available so you can get the flavor you crave wherever you are. Stop in today and see why locals can't get enough!

**UPCOMING EVENT?** SEND us details for your fundraisers, sales, theater shows, or anything else the community can support. We'll post it on our website's calendar. [articles@nickelsworth.com](mailto:articles@nickelsworth.com)

**Motorcycles & ATVs**



**1999 HARLEY-DAVIDSON** custom Softail with 40th Anniversary 110 S&S motor and aftermarket Arlen Ness parts, \$7000 OBO. 208-699-2630

**THREE 1970s SUZUKI** TS125 parts/ project enduros, \$1650. Rokon Scout, runs good, \$5400. Credit cards accepted, 208-762-5651

**BEAUTIFUL CUSTOM** Built one-of-a-kind motorcycle. Under 4000 miles, build is over 60,000. Comes with custom trailer; have all receipts, asking \$24,500. 208-659-6674

**BLACK SHEEP SPORTING** Goods. Home of the lowest prices on all things outdoors. In the Silver Lake Mall, 200 W. Hanley, CdA. 208-667-7831; [www.BlackSheepIdaho.com](http://www.BlackSheepIdaho.com)



**2008 HONDA VTX1300** with Voyager trike kit. Motorcycle is like new, housed inside during non-use. Mileage 8125. Trike kit can be removed for original two-wheel use. \$6100, 208-660-6587, CdA

**1979 CHRYSLER SNO** Runner Sno-Rabbit, original Running Survivor snow bike, \$4250. Brand new 21 MPH ebike pit bike, \$650. Good running XR50R kids off-road 4-stroke dirt bike, \$950. Nice 100cc mini-bike, \$550. Nice 200cc mini-bike, \$860. Accepting credit cards, 208-755-6656

**1966 HONDA CT200 TRAIL** 90 project bike, \$950. 1982 Honda CT70 Passport, runs good, \$1400. 2 Honda XL175 Project bikes, \$960. 2009 Polaris 500 X2 Sportsman 4-wheeler, nice condition, \$6200. 1986 Honda Fat Cat TR200, runs good, \$3600. Racing go-kart with Yamaha IT100 engine, \$2000. 1963 Honda Trail 55 project, \$2000. Rokon Scout, runs good, \$5400. Credit cards accepted. 208-762-5651

**1987 HONDA XL600 ON/** Off-road, nice original condition, \$3700. 2012 Polaris RZR 800 side-by-side, runs great, salvage title, \$6600. 1984 Yamaha Tri-Zinger 60 3-wheeler, \$1650; 40cc 4-stroke pocket bike, \$400. Honda eu2000i inverter generator, \$800. 2007 Harley Softail Chopper, nice condition, \$7700. 2003 Road King, nice condition, \$9750. Accepting credit cards, 208-762-5651

**2019 HONDA TALON 1000X** 3600 miles, extras, 1 owner, \$13,000. Kootenai County, 208-755-1863

**EARLY SPRING OFF ROAD SALE**  
 PLAN AHEAD-COME SEE US



**CRFs 50, 110, 250 & 450**

**CT125**



**YZs**  
**WR125**  
**TW 200**  
**TT-R50**  
**TT-R110**



**GET IN ON THE IN-STORE SPECIAL SAVINGS!**

**SHOSHONE HONDA YAMAHA**

208-682-2022 • 506 N. 1st Street, Pinehurst Idaho, 83850

**COUPONS ON FACEBOOK MONTHLY**  
*exclusives*  
**VISIT TODAY**  
**THE NICKEL'S WORTH**  
 SINCE 1972

[@NickelsWorth](http://facebook.com/NickelsWorth)

**Lost & Found**

**FOUND: TREK REAR** bicycle flasher light, found on Dike Rd. by NIC around May 5th. Call to identify, 208-661-1900

**LOST: SILVER NECKLACE** with unicorn pendant. Lost at Circle K in Post Falls, off Beck Rd. Please call Stephen, 208-704-3762

**TRIPLE B GUNS**  
 208-664-9053  
 4029 Govt. Way, CdA, Idaho  
**BUY • SELL • TRADE**  
 We Do Class 3 and Layaways!  
 Buying Collections Big & Small  
 Nice Selection Of New and Used Guns

## Hunting & Firearms

CD GUNSHOT MAUSER .30-06, set triggers, 4x scope, \$2250. Steyr-Daimler-Puch Mannlicher Model M. .30-06, set triggers, Leupold 3-9x scope, \$2000. Ruger No. 1 .45-70, Leupold 3-9x scope, \$2000. Ruger No. 3 .223 Berris 3-9x scope, \$1200. Ruger No. 1 .270 Winchester, Bushnell 4-12x scope, 12 boxes ammo, 100 rounds new brass, 500 bullets, new dies, \$1350. Winchester 1894 .32-40, octagon barrel, \$3000. 208-691-1250, Spirit Lake, ID

**Colligan's**  
**AUTO SERVICE**

COLLIGAN'S AUTO Service, 208-889-9547, 5250 E. Seltice Way, Post Falls. Colligan's Auto Service is now offering \$99 hourly shop rate for a limited time! Call for an appointment today!

MULTIPLE FIREARMS FOR sale. 450 Thumper, 12 gauge, 300, 223, 22, pistol, rifle, body armour, tactical vest, ammo, magazines, \$800. 509-592-8946, Rathdrum, ID

BERETTA 1301 TACTICAL C Model 2 semi-automatic 12 gauge, new, unfired with box, \$1500. 208-290-3576

ATTENTION VETERANS and active duty service members: Present your military ID or proof of membership in veterans' group at the Nickel's Worth office and get buy one get one free classified ads from that point on (ID only needed initially). Ads must run in the same week; free ad of equal or lesser value; display ads and picture classified ads do not qualify. Thank you for your service to our country!

REM. 700 .338 EDGE, 30" fluted barrel with brake, Cerakoted, 20 MOA rail, 105 pieces .300 RUM cases (new and once fired), Lee .375 and .338 RUM dies, \$1400. Ruger 10/22, new in box, \$300. Call or text, leave message, pics available, 208-755-5013, CdA

BUYING OLD US COINS. Graded and ungraded. Will look at entire collections. Call Mike at 801-808-0343, Post Falls

TOP DOLLAR PAID FOR quality firearms and related items. Old gold and silver coin wanted. Call or text 208-661-4598

## Series of Montana Poaching Crimes Leads to Lifetime Loss of Hunting and Fishing Privileges for Tennessee Man

— Montana Fish, Wildlife & Parks —

HAMILTON— Montana Fish, Wildlife & Parks game wardens report that Jerry "Trey" Truitt III of Tennessee was recently sentenced for wildlife poaching crimes committed in Ravalli County, resulting in a lifetime loss of hunting and fishing privileges. Truitt also had a prior history of poaching convictions in Ravalli and Lake Counties.

The most recent case concluded April 2 in Ravalli County Justice Court where Truitt pleaded no contest on five criminal counts related to poaching crimes he committed in 2024 and 2025. Truitt was convicted on two counts of unlawful possession of wildlife (turkey and sandhill crane), one count of hunting without a license, one count of criminal trespass, and one count for hunting during a closed season. Truitt hunted for turkeys without a license and killed a sandhill crane in Ravalli County, where there is not a season for cranes.

The original Montana case against Truitt related to poaching crimes he committed in 2024 in Ravalli County. He was originally convicted in Ravalli

County Justice Court in April 2025 on two counts of hunting without a license and two counts of unlawful possession of a game animal. He killed an antlerless elk and antlerless white-tailed deer in West Fork of the Bitterroot without a license.

In 2025 Truitt also pleaded guilty in Lake County Justice Court for obstruction of justice, using a license issued to another person, and violation of Commission rules and regulations related to unlawfully hunting waterfowl on Ninepipe Wildlife Management Area in 2024.

Ravalli County Game Wardens Taylor Gagnon and Shane Yaskus, and Warden Sergeant Lou Royce, led the Ravalli County investigations, and Warden Jake Pickens led the Lake County case. The earlier cases resulted in fines and restitution owed and some loss of hunting and fishing privileges, with the final sentencing bumping that into a lifetime loss.

"We would like to thank both county attorney's offices for all of their work through the years on these cases," said FWP Region 2 Warden Captain, Kyle Miller. "The Ravalli County Attorney's Office, and particularly Deputy County Attorney David Lakin, dedicated a lot of time and energy to these cases, and we appreciate his extra efforts."

FWP game wardens say that wildlife crime investigations like this one are often initiated or solved because of leads from the public. Visit [tipmont.mt.gov](http://tipmont.mt.gov) for more information on reporting natural resource crimes and who to contact in your local area.



BUYING ELK, MOOSE and deer antlers. Idaho cougars, wolves, black bear hides, claws, skulls. Carcass porcupines. Elk ivories. IDFG check station for bear and cougar. Custom tanning and skull cleaning. Moscow Hide and Fur, 208-882-0601, [www.furbuyer.com](http://www.furbuyer.com)

AMMUNITION: 223 Rem., 39¢ per round. 208-929-5016, CdA

VORTEX SPOTTING Scope, 20x60x85 HD, \$800; Vortex Kaibab Binos, 18x56, \$600; Swarovski 10x42 EL, \$1700. All have the lifetime warranty. Garmin inReach Mini 2, \$275. Pictures online at [www.nickelsworth.com](http://www.nickelsworth.com). Call or text 602-618-6849, Post Falls

100% RUGER SP101, .357 Magnum/ .38 Special, single action/ double action 5-shot SS revolver. 2-1/4" BBL, black composite grips, molded black leather holster and 50 rounds of Winchester +P, 125 grain. JHP Personal Protection ammo. Beautiful, can just barely see the roll mark on the cylinder. Like new, \$900 cash, no trades. Idaho resident, 21 years old and FFL paperwork required. 208-721-7447, Spirit Lake, ID

AMMUNITION: 7.62x39, 56¢ per round. 208-929-5016, CdA

GOT GUNS? WE purchase firearms! Quick, friendly and secure assessment. Come to us or we will visit you. We are a fully licensed PFL (Federal Firearms Licensee) and offer the safest, most convenient way to sell your firearms hassle free. Paying top dollar, 40+ years experience. Paid in cash, bank wire, or cashier's check. Call Matt, 509-993-5198, or Aaron, 208-704-4063

BLACK SHEEP SPORTING Goods. Home of the lowest prices on all things outdoors. In the Silver Lake Mall, 200 W. Hanley, CdA. 208-667-7831; [www.BlackSheepIdaho.com](http://www.BlackSheepIdaho.com)

WANTED: 22 HIGH Standard semi-automatic. Call 986-205-3227, Bonners Ferry

CUSTOM GLOCK 43X. Apex trigger, tungsten slide spring, tritium front and rear sights (green), two mags, Kydex holster, Hogue grip. Over \$900 invested, selling for \$650. Call Mike at 208-290-7229. Idaho residents only

WE MAKE IT EASY TO submit your ad! You can call 208-667-0651, go through our website at [www.nickelsworth.com](http://www.nickelsworth.com), email [ads@nickelsworth.com](mailto:ads@nickelsworth.com), regular mail to PO Box 2048, Coeur d'Alene, ID 83816 or come by our office at 107 5th Street, also in Coeur d'Alene

RUGER NO. 1, 257 Roberts; Ruger No. 1, 7mm; Browning 1885, 22-250; Weatherby Mark V, 338 Weatherby RPM; Winchester M70, 375 H&H; Winchester M100, 308 (x2); Winchester M100, 284 Win; Winchester M70, 30-06; Winchester M88, 308; Remington M740, 30-06 (x2); Remington M742, 30-06; Remington M742, 6mm; Remington M141, 35 Rem; Savage 98M, 308; Savage 99, 22 HP; Savage 99, 300 Savage; Marlin 336, 30-30; Marlin XLR, 444 and 45-70; Winchester 94 (x6); Winchester 1882, 25-20; Winchester 64, 30-30; Remington 1109, 12 ga.; Fox Sterlingworth, 12 ga.; Winchester 24, 16 ga.; Remington 870 (x2); Enfield No. 4 MK1, 303 Brit; Enfield 1915, 303 Brit; Freedom Arms, 454 Casull; Ruger Hunter, 44 Mag. Come see these and many more at Gem State Firearms located at 3700 N. Government Way, CdA

HAND GUNS. SMITH & Wesson M&P 10mm. M2.0. Mag 15+1. Like new! \$625. Springfield XDM Elite 10mm. Optic ready. Three mags 15+1. Brand new! \$675. Springfield XDS 45ACP. Three mags 6+1. Like new! \$575. Smith & Wesson M&P 45 M2.0. 45 auto. Threaded barrel. Two 10+1 mags. Like new! \$625. Glock G42 .380 auto. Two 6+1 mags. New! \$495. Smith & Wesson .380 Shield EZ M2.0. Mag 8+1. Like new! \$425. Walther P22 22LR. Threaded barrel. Mags 10+1. Like new! \$395. Glock 17. Gen 4 9mm. Three mags 17+1. Like new! \$625. Glock 43. Gen 4 9mm. Five mags. Like new! \$625. Beretta PX4 Storm .40. Mag 14+1. Like new! \$575. Ruger SR22 22LR. Holosun green dot laser. Like new! \$475. Springfield XD-45 ACP. Two mags 13+1. Like new! \$575. Savage Stance MC9. 9mm. Ported. Two mags 8+1. new! \$450. Canik Mete MC9. 9mm. Two mags 15+1. Optics ready. New! \$525. Canik TP9SA. Mod. 2. 9mm. Two mags 18+1. New! \$475. Smith & Wesson M&P9 Shield 9mm. Ported. "Performance Center." Two mags 8+1. Like new! \$575. Smith & Wesson M&P9 9mm. M2.0. Ported. "Performance Center." Two mags 17+1. New! \$775. Smith & Wesson M&P9C 9mm. Crimson Trace laser. Mag 9+1. Like new. \$500. Smith & Wesson M&P9C 9mm. three mags 12+1, 11+1, 10+1. New! \$550. Smith & Wesson M&P9 Shield 9mm. Two mags 8+1. Like new! \$485. 208-626-5491

LOG CABIN IN THE Woods, 320 sq. ft. (about 16'x20') on hard to find 10 acres in the Priest Lake area. Borders state land on one side with private land and small lake access on the other. Good hunting, fishing, snow shoeing, ATV, or just a getaway. Dry cabin, generator, water tank, outdoor shower, wood stove and/ or propane heat. End of the road privacy, attached carport, one out building for storage and outhouse. Private sale, no agents. \$385,000. 208-755-0464

COLLIGAN'S AUTO Service, 208-889-9547, 5250 E. Seltice Way, Post Falls. Colligan's Auto Service is now offering \$99 hourly shop rate for a limited time! Call for an appointment today!

MINI 14, ATI STOCK, \$1100. Ithaca double barrel 12 gauge coach gun, \$300. Savage Enfield, in like new condition, \$400. 208-651-6609

WORK LATE? NICKEL'S Worth has a front-door mail drop, 107 N. 5th St., CdA

WINCHESTER M70 Classic Sporter .338 Win. Mag. Like new in box, \$850. 907-502-0146, Kootenai County

**WANTED**  
 30 CAL. MI CARBINES  
 Top \$\$ Paid for Condition  
 US Shotguns & Pistols!  
 ALSO BUYING COLLECTIONS!  
**208-691-7566**  
 Leave message, will return calls

**ARMORY OUTPOST**

Cerakote • Gun-Kote • Parkerizing • Custom 1911 Work  
 New/Used/Consigned Firearms • Body Armor

**SALES ★ REPAIR ★ PARTS**

Competitive Pricing  
 First Responder/Military Discounts  
 Gift Certificates & Gun Saving Plans Available

**AUTHORIZED DEALER OF ARIZONA REGULATOR FRT'S**

**208-518-1048** • 9515 N. Government Way • Hayden, ID  
 Tuesday-Saturday 10am-6pm • Closed Sunday-Monday • [ArmoryOutpostIdaho.com](http://ArmoryOutpostIdaho.com)

**GEM COUNTRY ROOFING**

Install and repair all types of roofing  
Commercial and residential  
Snow removal

Call George  
**208-819-9929**  
Lic. RCE-45667 • Insured

**FREE ESTIMATES**

## Services

**PEAK'S CARPET CARE**  
Carpet & Upholstery Cleaning

208-699-2096 or 208-683-1662

Cleaned right the 1st time | Free Estimates! Great Rates!

UNDERGROUND UTILITY and pipe locating. Private side only. Credit cards accepted. Veteran owned. Call or text 208-691-6726

WILL PICK UP unwanted cars and trucks free. 208-263-4639

**JURGENS CONSTRUCTION**  
REMODELS & NEW CONSTRUCTION  
Siding • Windows • Decks  
**208-651-7559**  
Free Estimates • Lic. & Insured



HIGHER ME SERVICES, 936-933-5317, CdA. Looking to add to your landscaping or design a new one? I design, then install. My designs include beautiful planting, stone and paver patios, beds, walkways, firepits, and small water features

**TOP SOIL • FILL DIRT  
SEPTIC • WATER • BASEMENT**  
Equipped For Travel  
*Alamo Excavating, Inc.*  
Licensed • Bonded • Insured  
Jeff Wood **208-773-8480** RCE-15178

**AFFORDABLE ROOFING & REPAIR SERVICE**

Why replace your roof when you can just fix it?

**RE-ROOFS & REPAIRS**  
Over 30 Years Experience  
Licensed & Insured

**Freddie**  
**208-704-2190**

## Ribbon Cutting for Kokanee Cove

— Ponderosa State Park —

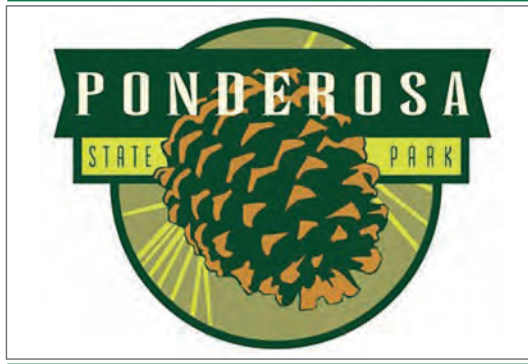

Join Idaho State Parks and Recreation for a ribbon cutting ceremony to celebrate the grand opening of the Kokanee Cove cabins and event center at Ponderosa State Park.

"Nestled in one of Idaho's favorite destinations, Kokanee Cove is a new lakeside space designed for connection, celebration, and unforgettable moments. Whether you're planning a private event, a group getaway, or a cozy cabin stay, this spot is ready to welcome you," Idaho Parks and Recreation said.

The ceremony will begin at 3pm Mountain Time on Tuesday, June 2nd, at 1920 Davis Ave. in McCall, Idaho.

JEDIDIAH DANIEL Services is offering spring clean up to help tidy up your property and give it a respectable look. Our services include, but are not limited to: leaf, brush, pine needle, debris, weed, and junk removal. We are hardworking young adults with the intentions of finishing the job and creating a result that pleases customer expectations. If you wish a free quote, give me a call at 208-786-0299

EXCAVATION: HAVE A challenging building site? Give us a call. Serving Shoshone and Benewah Counties. Serving North Idaho for over 20 years. Call or text: 208-691-6167 or 208-627-2010

**Colligan's**  
AUTO SERVICE

COLLIGAN'S AUTO Service, 208-889-9547, 5250 E. Seltice Way, Post Falls. We're offering a free computer system scan! Domestic and Asian cars and trucks. Limited time offer! Come in today!

ARCHITECT QUALITY without architect prices! Let RADD Drafting & Design help you to prepare for spring construction. We design custom homes, single and multi-family, additions, remodels, and decks. RADD Drafting, where affordability meets 20+ years of experience. Free consultation. Call Rob, 208-691-2086



DON'T HESITATE ON drilling, I'll find the spot for your well. Rich the Well Witcher, references available. 208-771-3339, richbrodka@gmail.com. Idaho, Montana, Washington

HAVE TRUCK AND trailer and am ready to work! Dump runs, yard clean up, material hauling, etc. Call Garth, 208-704-9441

CONCRETE FLATWORK Specialists. 25+ years experience. All types. Licensed and insured, #RCE-63985. Email petesconcrete2022@gmail.com or call or text Pete at 208-277-7979

## Tools & Building Materials

VULCAN OMNIPRO 220/110 volt multi-purpose 220 amp MIG welder, \$950. New 6.5HP 2" water pump, \$320. Pair of Honda EU2000i inverter generators, good condition, \$1650. Honda 2" water pump, works great, \$440. SpeeCo log splitter, Honda engine, works great, \$1950. Like new condition Stihl 026 chainsaw, \$650. Honda EU3000IS inverter generator, \$1650. Honda EM2500 generator, \$850. Honda EU2000i inverter generator, \$800. Lincoln 140 wire feed MIG welder, \$470. Accepting credit cards. 208-762-5651

STYROFOAM BEAD insulation, \$5 per 55 gallon bag. Located near Newport. You haul. 208-610-5605

NICE DEWALT HONDA gas powered wheelbarrow air compressor, \$950. 2.5HP 12 gallon air compressor, \$180. Good cherry picker engine hoist, \$310. EU6500is Honda inverter generator, excellent condition, \$3800. 7850 Maximum Champion dual fuel generator, \$880. Kohler Amp Command 9500 portable welder/generator/air compressor, \$4100. Huge Matco toolbox, 12'Lx70"Hx31"D in excellent condition, \$15,800. Stihl 036, runs good, \$600. Lincoln 225 welder, \$300. Two coal blacksmith forges, \$250 and \$660. Like new plate compactor, \$865. Several ladders, \$80-\$750. Accepting credit cards. 208-762-5651

SMILE, YOU ARE GOOD

Get Your **NICKEL'S WORTH**

**2026 Home Improvement Special Issue**

A special pull-and-save issue →



# HOME IMPROVEMENT



**REPAIRS**  
**NEW ROOFS**  
**RE-ROOFS**  
**10% Veteran Discount**

Free estimates & consultations • Excellent quality  
30 years experience • Licensed & Insured

**208-964-4999**

[www.djsroofingcontracting.com](http://www.djsroofingcontracting.com)

## Services



**CERTIFIED ARBORIST**  
Pruning • Thinning  
Removal • Stump Grinding

**Matt Gray - Trask**  
**208-714-9414**  
Athol, Idaho

State Lic. No. RCT-42772  
WE-5152A

**ANDERSEN EXCAVATING** Inc., 208-699-5963. Site work, septic system, dump truck, backhoe, Cat work. 37 years in Kootenai County. Been here longer because we do it right. License #RCE-1537

**RANDY'S HANDYMAN.** Yard and property cleanup services special. Free estimates, professional results. Offering building repairs and demolition. Docks, water features, landscaping, concrete, tree climbing, trimming and removal, block and boulder retaining walls, fencing, lot clearing and yard prep, tractor work and field mowing. Discounts and financing for seniors. 208-699-2787

**RV SERVICE TECHNICIAN** available for service and repair on all makes and models of RVs. Time to summerize and get ready for summer! We also transport and relocate RVs of all types. 30 years experience; fast, professional service, reasonable rates. Please call 208-783-5229

**CUSTOM HOMES,** remodels, additions. Specializing in ICF and structural concrete construction. Decks, timber framing, shops, barns, pole buildings. Full turnkey design-build services from concept to completion, in-house permit ready design and drafting including 3D modeling. Serving North Idaho for over 12 years. Valhalla Construction LLC, RCE-35813, [www.valhallaconstllc.com](http://www.valhallaconstllc.com). Call/text 208-691-6726. 100% Veteran owned business

**MIKE'S TRACTOR Services.** Snow removal, backhoe work field mowing, rototilling, brush cutting, post digging, moving dirt, gravel, etc. 208-889-8635



**AUTO SERVICE**

**COLLIGAN'S AUTO Service,** 208-889-9547, 5250 E. Seltice Way, Post Falls. Colligan's Auto Service is now offering \$99 hourly shop rate for a limited time! Call for an appointment today!

**ROTOTILLING AND FIELD** mowing, also handyman. No job too small or too large. Jim, 208-777-5456 for information and estimates



## 250 Years of Freedom by Jim H.

**INSTALLATION AND** Repair of all types of fencing! Quality, speed, and good prices! Call 208-618-9885 for a free estimate, Post Falls, ID

**IN IDAHO FROM VIOLA** to the Canadian border, in Montana from Hamilton to Troy, in Washington from Spokane to Newport: The Nickel's Worth has you covered

**TREES AND SHRUBS.** Beautifully trimmed or removed, landscape repair. 30+ year expert, insured. Call John at 208-610-5759

### Housekeeping & Carpets

**ONE MOM AND A MOP** wanting to clean your home! Dependable, trustworthy, and thorough! Great references, fixed rates. Call for free estimate! 208-819-0206

**ALL PHASES OF CONCRETE**

**WOLF FOUNDATIONS & FLATWORK, LLC**



Footings  
Foundations  
Slabs/floors  
Porches  
Retaining walls  
Remove & replace  
Decorative

**208-449-6908**

Hayden | RCTE-49838

**CONCRETE FLATWORK.** Driveways, walkways, patios, shop floors, slabs. New or remove and replace. Kootenai County, free estimates, licensed and insured, 208-704-6462

**CARPENTER FOR HIRE.** Owner builders welcome. 208-699-1233



**DEPENDABLE DAN** Handyman Services. Experienced craftsman, quality workmanship. Residential and commercial installation, improvements and repairs, no job too small. Licensed and insured, your satisfaction guaranteed! Call Dan at 208-620-6388

**OLDER CAR REPAIR** specialist and carburetor expert. Call Dennis, Mobile Auto Tech, 208-704-1565

**NURSE NEXT DOOR** offers home health services! PT, OT, wound care. Accepting VA TriWest, Medicare, Blue Cross, long term care insurance, private pay. Veterans, ask your doctor about HHA program! Contact us at 208-600-1899

**HOLIDAY HANDYMAN.** Decks, painting, small jobs, emergency repairs, roof leaks, siding, replace toilets, interior trim, exterior doors. 208-659-1104

**COLLIGAN'S AUTO Service,** 208-889-9547, 5250 E. Seltice Way, Post Falls. We're offering a free computer system scan! Domestic and Asian cars and trucks. Limited time offer! Come in today!



**Selkirk SHOPS**

**SHOPS & SHOPDOMINIUMS**  
BUILT TO LAST FOR GENERATIONS

**STICK FRAMED**

ON TRUE

**STEM WALL FOUNDATIONS**

  
STICK-FRAMED CONSTRUCTION

  
TRUE CONCRETE STEM WALL FOUNDATIONS

  
SUPERIOR INSULATION

  
NO POSTS. NO ROTTING. NO WARPING.

**BUILT BETTER, LOOKS BETTER, IS BETTER.**



NOW SCHEDULING  
**2026 PROJECTS**



**(208) 290-1951**

LOCAL. EXPERIENCED. COMMITTED TO QUALITY. | CONTRACTOR REGISTRATION #8771160



Additions • Decks • Painting  
Appliance Installations • Hauling  
Gutter Cleaning • Debris Cleanup  
Pressure Washing

**FROM ROT REPAIR TO REMODELS-WE DO IT ALL!**

Lic. RCE-48833 • Insured **208-755-0915**



[www.sopersmobility.com](http://www.sopersmobility.com)  
**Stairway Lifts**

As low as \$4,495.00 Installed,  
within 25 miles.

Call today for your free home assessment.

Soper's Mobility, LLC  
2186 W Soper Ave  
Hayden, ID 83835  
(208) 772-6474

# SPECIAL ISSUE 2026



## Tree Trimming & Removals

**Commercial • Residential**  
Fully Licensed & Insured  
Tree & Landscape Service  
ISA Certified



CUTTING THE GREEN

Serving Coeur d'Alene since 2005 **208.772.5800**

CHECK OUT OUR WEBSITE AT: WWW.CUTTINGTHEGREEN.COM

## Services

### BFH CONSTRUCTION

**Home remodeling specialist!**  
Remodeling & additions  
Bathrooms & kitchens • Bobcat work  
25 years exp. • Licensed • Insured

Call Kevin  
**208-640-3990**

YOU CALL, WE HAUL! IDAHAUL specializes in clean-outs, construction debris, demolition and removal, yard waste and more! We offer affordable, straight-forward pricing. Veteran owned, serving Kootenai county. Call us for a quote today, 208-446-8054

DEMOLITION, LAND clearing, site prep, excavation and grading, road construction, post hole drilling up to 36", underground utilities and trenching. Valhalla Construction LLC, RCE-35813. Call or text 208-691-6726. 100% veteran owned. Credit cards accepted

**STUMP GRINDING**  
**208.772.5800**  
CUTTING THE GREEN

BLACK SHEEP SPORTING Goods. Home of the lowest prices on all things outdoors. In the Silver Lake Mall, 200 W. Hanley, CdA. 208-667-7831; www.BlackSheepIdaho.com

MD CONSTRUCTION. Commercial and residential. RCT-53025. Bonded and insured. Small repairs, kitchen, bath remodels, ceiling fans, decks, patios, lean-tos, exterior and interior painting. Call me for projects that you need not on this list. Kootenai County. Call Mark Decker at 208-603-0686

LOOKING FOR WORK building decks or out buildings and any other small jobs. I have experience and tools for most tasks. If you're planning on building anything around your property this summer, please call Danny, 208-416-1336, Kellogg, ID

## PRISTINE CLEAN

**Moss Removal - All Roofs**  
Sidewalks & Driveways  
Gutter Clean/Repair  
House Washing

### ROOF & GUTTER

**208-930-4370**

FREE estimates • Call James today!  
Licensed, bonded & insured • Serving 15 years

## Kurt Beyersdorff

### Hardwood Floors

**Flooring installation  
repairs & refinishing**

**BEFORE**

**REASONABLE PRICES!!!**

**AFTER**

Contact Us!  
**208-215-0711**  
**floorplan411@gmail.com**

ID license # RCT- 61269

## Unleash Your Adventurous Spirit At Summer Becoming An Outdoors-Woman Workshop

— Montana Fish, Wildlife, & Parks —

Don't let the catch of the season get away! Apply for Becoming an Outdoors-Woman Summer Camp July 31 – Aug 2. Follow the fly fishing track to dive deep into Montana's iconic fishing. Applications open May 15.

Escape to the breathtaking Lubrecht Forest July 31 through Aug. 2 for a weekend of self-discovery, adventure and hands-on learning in the great outdoors.

The Summer Becoming an Outdoors-Woman (BOW) workshop is a three-day immersive experience, kicking off at noon on Friday and wrapping up around 1 p.m. on Sunday. Nestled in a camp setting, your stay includes lodging or space for your tent/camper and meals, so you can fully embrace the outdoor experience.

Over the weekend, you'll dive into four engaging instructional sessions, each 3.5 hours long, where you'll build new skills in a supportive, noncompetitive environment. Classes are hands-on and held outdoors as much as possible, giving you the chance to learn by doing while surrounded by Montana's stunning landscapes.

And the fun doesn't stop when the sun goes down. Evenings are filled with camaraderie, special activities and even more opportunities to learn and connect. Whether you're looking to master a new outdoor skill or deepen your connection with nature, there's something for everyone.

Come as you are and leave with new skills, new friendships and unforgettable memories.

Check out the information packet on our website at [fwp.mt.gov/education/becoming-an-outdoors-woman](http://fwp.mt.gov/education/becoming-an-outdoors-woman) for a full description of the application process, workshop schedule and class options. Applications open online May 15 at 10 a.m. at [forms.office.com/g/950L7KyTvP](http://forms.office.com/g/950L7KyTvP).

Questions about BOW? Contact Kylie Kembel at 406-444-5280 or [kylie.kembel@mt.gov](mailto:kylie.kembel@mt.gov).

WILHELM'S CREATIVE Home Renovations, LLC. Contractor license #1871997. Happy to help you with spring projects, handyman services, remodels, additions, custom decks, doors, windows, trim work, new construction. Over 30 years experience. Post Falls native. Home of the "Call today, get your estimate today." 208-625-8733 or 208-582-1666

HANDYMAN SERVICES and general contracting. We solve any problem in your house. Small and big projects are welcome. New construction, remodels, repairs, kitchens, bathrooms, doors, windows, sheetrock, painting and wallpaper, tiles, carpentry from framing to finish, decks, sheds, lean-tos, fences, yard cleanup, etc. Call 208-304-8878 for free estimate. 35 years experience. Insured. Lic. #RCE-65790. John 3:16

CARPENTER/ HANDYMAN looking to help you on your home repair and improvement projects. All residential work from little fixes to decks, fences, siding, finish carpentry, wood and laminate flooring, tile, drywall, painting, doors, windows, bathrooms, remodels and additions. 20+ years experience. Quality work, reasonable rates. Dave, 208-610-2277

CARPET REPAIR, installations, and restretches. 40 years experience, work guaranteed. Call Walter at R&R Floors, 208-755-5573

OLDER CAR REPAIR specialist and carburetor expert. Call Dennis, Mobile Auto Tech, 208-704-1565

YARD WORK/ CLEANUP. Willing to come to your place and do yard clean up or inside work. Minor carpentry, painting, or outside work. Any tools/ handles restained or painted. Can haul things to dump if needed. Good pricing, good estimates. Please call 208-277-5408, 208-755-4994

## BENNETT CONCRETE

All phases of flatwork, demo and site prep

**208-699-4295 / tadpolesdad5@gmail.com**  
Free estimates • Licensed & insured  
Rathdrum, Idaho • 30 years in business • No job too small

### AUTO SERVICE

COLLIGAN'S AUTO Service, 208-889-9547, 5250 E. Seltice Way, Post Falls. Colligan's Auto Service is now offering \$99 hourly shop rate for a limited time! Call for an appointment today!

ERICKSON CONCRETE & Masonry LLC. Over 40 years experience. Stone, brick, block, cement, stamped concrete, fireplaces, chimney repair, veneer, patios, outdoor kitchens, columns, etc. Call for a free estimate! 208-889-9690

HOUSE JACKING/ Leveling. Foundation, crawl space/ basement repair. Mold and moisture damage remediation. Over 30 years of guaranteed quality. Jack, 509-209-6094

MASONRY RESTORATION, repair, repointing of joints, building piers and building leveling. Rock work, masonry. Call Al, 208-512-4995

NEED A MECHANIC? Tired of high shop prices? I offer a mobile mechanic service with over 20 years experience in a full service shop. Able to fix almost anything on most vehicles, big or small. Contact JD at E.I. Mobile, 208-660-8564

BFH CONSTRUCTION: Home remodeling specialist! Kitchens, bathrooms, new construction. Decks, Bobcat work. 25 years experience. Licensed (#RCE-21605); insured. Kevin, 208-640-3990

### Troyer's Seamless Rain Gutters

*Your satisfaction is our priority.*

40 colors to choose from to suit all your needs.

5" Seamless Gutter • Repair & Cleaning  
Leaf Guard • Ornamental Chain Downs

Licensed & Insured  
**(208) 987-0414**  
email: [troyerfamily8@gmail.com](mailto:troyerfamily8@gmail.com)  
1000 Ellis Lane, Plummer, ID

## TROUT CREEK TRUSS

- Truss Designs & Quotes
- Material Quotes
- Perma-Columns & Post Brackets
- Serving MT & North ID

993 MT HWY-200, Noxon, MT  
 406-847-7663  
[info@troutcreektruss.com](mailto:info@troutcreektruss.com)



**FINANCING AVAILABLE!**

**IDAHO FENCE**  
Do-It-Yourself  
**MAY SALE!**  
5/1-5/30

**VINYL PRIVACY**



**MADE IN THE USA**

- 6' White Privacy..... \$14.00 /ft
- 6' Sandstone Privacy..... \$16.00 /ft

**VINYL RANCH RAIL**

**10% OFF**



2 Rail White and 3 Rail White

**CEDAR PRIVACY FENCING**

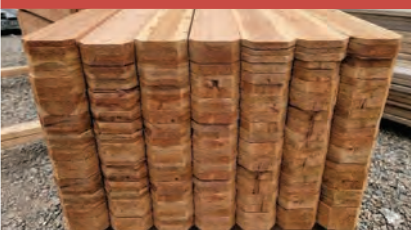

**THE ONLY POST FOR CEDAR PRIVACY!**

- 5/8" x 6" x 6' #2 or Better Cedar Picket..... \$2.99
- 3/4" x 6" x 6' #2 or Better Cedar Picket..... \$3.59
- 4" x 4" x 8' Pressure Treated Post..... \$15.00
- 4" x 4" x 10' Pressure Treated Post..... \$22.00
- 7'6" Galvanized Grizzly Post..... \$32.00
- 7'6" Black Grizzly Post..... \$35.00

**FORTRESS ORNAMENTAL STEEL**

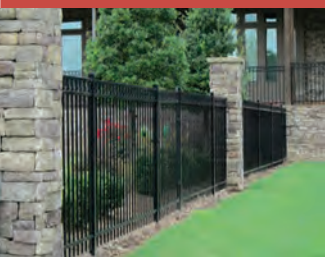

Beautiful and maintenance free.  
4' x 8' Panel  
5' x 8' Panel  
6' x 8' Panel  
**10% OFF**

**SPLIT RAIL CEDAR**



- 2-Rail..... \$5.80 /ft
- 3-Rail..... \$7.73 /ft

**CONTINUOUS PANEL FENCING**



- 48" TALL x 20' WIDE**
- 4 - Rail..... \$102.00
  - 5 - Rail..... \$120.00
  - 6 - Rail..... \$150.00
  - Clip (Weld-on or Screw-on)..... \$0.68

**TREATED WOOD POSTS**



**Idaho's Fencing Headquarters**

- 4-5" x 7' Driver..... \$10.99
- 5-6" x 7' Driver..... \$14.50
- 4-5" x 8' Driver..... \$15.00
- 5-6" x 10' Driver..... \$29.00
- 5-6" x 12' Driver..... \$30.00
- 4-1/2" x 16' Treated Half-Round..... \$18.00

**PREMIUM HEAVY DUTY T-POSTS**

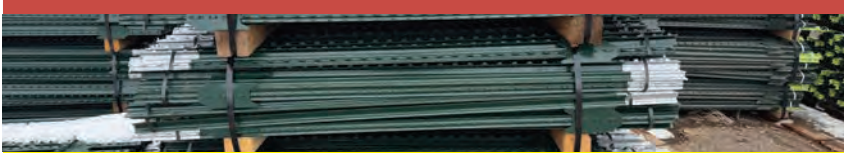

- Premium 5'6" 1.33#..... \$4.89
- Premium 6' 1.33#..... \$5.29
- Premium 7' 1.33#..... \$6.70
- Premium 8' 1.33#..... \$7.30
- Premium 10' 1.33#..... \$9.80

**CHAIN LINK FENCING**

Galvanized and Black

**10% OFF**

**BARBED WIRE**



- COMMERCIAL 4pt 12.5ga..... \$110.00

**GAME AND GARDEN FENCING**



- 7'6" x 100' Black Deer Netting..... \$139.00
- 7'6" x 330' Black Deer Netting..... \$310.00
- 6'6" x 165' Game Fence..... \$195.00
- 6'6" x 330' Game Fence..... \$390.00
- 8' x 330' Game Fence (6" Spacing)... \$590.00

**LIVESTOCK PANELS**

- 50" x 16' Cattle Panel..... \$30.00
- 48" x 16' Sheep & Goat Panel (4x4 squares)..... \$40.00

**HORSE SHELTERS 12x12**

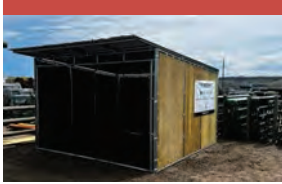

**NOW AVAILABLE FOR \$2,800.00!**  
While Supplies Last

All items limited to stock on hand, while supplies last - sale pricing not to be combined with installations. More inventory in stock.

**OPEN MON - FRI: 8AM - 5PM • SAT: 8AM - 4PM • SUN: CLOSED**



**POST FALLS | (208) 687-2296**  
2430 W Seltice Way Post Falls, ID 83854  
**IdahoFence.com**

SALE ENDS 5/30/26

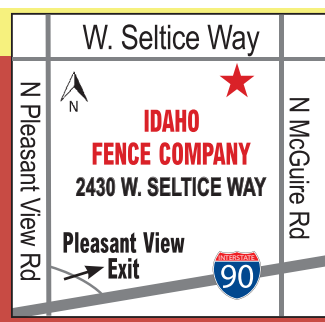

# SPECIAL ISSUE 2026



**The PLUMBER**

Sewer and Drain Cleaning  
Truck Mounted Hydro Jetting  
Full Service Plumbing and Repairs

**(208) 916-3520**

David Wyatt • Licensed/Insured • theplumber208@gmail.com



by Ryan A. Berenz

1. Which World Golf Hall of Famer became the first female to shoot lower than 300 in a 72-hole tournament when she won the 1947 U.S. Women's Open with a 295 score?
2. The San Diego Sockers, New York Arrows and Baltimore Blast were among the most successful teams in what arena soccer league that played from 1978 to 1992?
3. Which U.S. state's legislature passed Act 130, commonly called the 1936 Sunday Sports Law, which permitted professional sports to be played on Sundays?
4. He was selected by the San Francisco 49ers with the final pick of the 2022 NFL Draft. His young brother played college football for Florida State, Nebraska and Nevada. Who are they?
5. Name the pitcher who won the National League Cy Young Award with the Philadelphia Phillies in 1987 and won a World Series title with the Minnesota Twins in 1991.
6. The Women's Basketball Hall of Fame opened in 1999 in which U.S. city?
7. Which two college football teams have played for the Land of Lincoln Trophy (a bronze stove-pipe hat) since 2009?

- Answers**
1. Betty Jameson.
  2. Major Indoor Soccer League (MISL).
  3. Pennsylvania.
  4. Brock and Chubba Purdy.
  5. Steve Bedrosian.
  6. Knoxville, Tennessee.
  7. The Illinois Fighting Illini and the Northwestern Wildcats.

WE MAKE IT EASY TO submit your ad! You can call 208-667-0651, go through our website at [www.nickelsworth.com](http://www.nickelsworth.com), email [ads@nickelsworth.com](mailto:ads@nickelsworth.com), regular mail to PO Box 2048, Coeur d'Alene, ID 83816 or come by our office at 107 5th Street, also in Coeur d'Alene

**Sale!**

In March, April & May

**"Honey Do" PAINTING**

All new interior work  
**ONLY \$55 PER MAN HOUR**  
plus materials

**10% OFF**  
All new exterior work booked now  
Early season discount!

New construction & residential • Interior & Exterior  
Reliable • Affordable • Professional Workmanship  
Free estimates • We will beat any written price  
10% senior/veteran discount • Licensed & Bonded  
1 Corinthians 10:31 10% of proceeds go to charity of your choice

**(208) 699-1790 • honey-do-painting.com**

## Plumbers

**POST FALLS PLUMBING**

REMODELING SPECIALIST  
Replace Fixtures • All Residential Repairs  
Senior Discounts • Licensed & Bonded

OFFICE: **208-773-1259** CELL: **208-777-5707**

RANTS PLUMBING INC. For all your plumbing needs, including remodeling and services. Serving North Idaho since 1981. 208-691-4322, CdA

BIONDO'S/ MR. FAUCET, all plumbing services, 24/7. Nick, 208-682-0890

WHY PEOPLE LOVE US! "I sold all the puppies on the first day! Almost everyone who called said they found the ad in the Nickel's Worth! It was great!" Kathleen, August 2025

PLUMBING CONTRACTOR. Licensed, bonded, insured. Quality work, reasonable rates. 208-659-8070

**PLUMBING AMERICA NW**  
HEATING & COOLING

**Full Plumbing Services**

Service & Repair  
Remodels / New Construction

Friendly, honest, quality work at a fair price since 2006  
Veteran owned • Veteran discounts

Call for our monthly specials!  
**208-640-9062**  
Licensed, bonded & insured

## Painters

DOUBLE R REMODELING and Handyman services, for all your home improvement needs. 30+ years experience. RCT-22215. Ryan, 208-691-9940, North Idaho

SARAD PAINTING. Serving North Idaho for 30+ years. Interior/ exterior repaints, new construction, residential and commercial. Idaho license RCT-1553, completely insured. Call Bryan for a free estimate, 208-818-4304

MIKE BRYANT PAINTING. Licensed and insured. Interior and exterior, free estimates. 406-300-2570, Post Falls, ID

IN IDAHO FROM VIOLA to the Canadian border, in Montana from Hamilton to Troy, in Washington from Spokane to Newport: The Nickel's Worth has you covered

JAY'S CUSTOM PAINTING Plus. Specializing in interior/ exterior painting and staining, high pressure washing, crown molding, finish carpentry and drywall repairs. Over 20 years experience, licensed, bonded and insured. Call Jason for a free estimate, 208-691-3042

NORTHWEST PAINTING & Powerwashing. All phases of interior and exterior painting. Residential repaint specialists. Premium lifetime paint used on all projects. 10% senior discount. Brian, 208-699-5896

## Electricians



30 YEARS EXPERIENCE. Service is our specialty. Service calls or any electrical project. We give free estimates. License #21938. 208-771-1253



**Peace of Mind or Early Detection**

Now, More than ever, it's important to get screened for **Stroke and Cardiovascular Disease Risk**

It's simple and painless.

**833-970-4172**

★★★★★

**CHAMPION STEEL BUILDINGS**  
Scott Cook

Serving our community for decades in the Pole Building Industry.

**Pole Building Kits**  
Offering complete Polebarn Packages!

Packages Includes:  
\*Engineered Plans  
\*Timely Delivery

Call Scott Cook  
208-964-6666

Save Time & Money! Order your Polebarn Package Today!  
[championsteelbuildings.com](http://championsteelbuildings.com)

## Healthcare Fraud & Scams Could Affect Your Medicare

Check and Track Your Medicare Statements With Your **FREE Health Care Tracker**

CALL TO FIND OUT HOW  
**208-929-4071**

**VOLUNTEER with SMP!**





# HOME IMPROVEMENT

## KNOT HEAD TREE CARE

Voice For The Trees



208-916-2550  
knotheadtreecare.com

- Planting • Pruning
- Removal • Stump Grinding
- All Landscape Needs

Licensed & Insured



## Gardening & Landscaping

**TIME TO TILL! GARDEN** rototilling, large or small. 208-818-5158, CdA and surrounding areas

**CDA ANNUAL BLUE WOLF** Community Club Plant and Yard Sale 5/15-5/16. 8am-4pm Friday-Saturday; half price Saturday, that means \$1.50 plants! Nice variety of plants, annual, perennial, vegetables and berries. 2000+ sq. ft. of second hand treasures. Many 25¢ through \$5 including outdoor items, and jacuzzi tub. Refreshments available. 4479 S. Blue Creek Rd.

**CASEY BROWN'S MOW,** Blow and Go! Will mow, string trim and blow for one reasonable price. Please give us a try, 208-667-5790, 208-714-2364

**AERATING:** CDA, Post Falls and surrounding. 208-457-2567

**SNOW/ GRADING BLADE,** Craftsman, 42", for front of garden tractor, model 486244412, works well, \$100. 208-671-4976

**GARDEN TILLER, LARGE.** Craftsman, 5HP, rear tines, counter rotation 7" tine, \$250. 208-671-4976

**MOSER'S LAWN CARE,** 12 years service. 208-964-5318

**SPEECO 20 TON LOG splitter,** \$1250. Echo Bearcat Pro 14.50 chipper shredder, \$1650. Craftsman 46" lawn tractor, \$1360. Craftsman 7HP 17" dual direction rear tine rototiller, like new, \$1130. Stihl MM55 mini tiller, \$350. 5 ton electric log splitter, \$290. Nice John Deere JX75 21" commercial lawnmower, \$700. Tune-up and repair on power equipment. Accepting credit cards, 208-762-5651



Formerly American Mower & Saw.

Family owned for 45 years! Under new ownership/management!

Outdoor Power Equipment Sales & Service

Commercial & Residential Product Lines

Tune-Ups, Sharpening, Major & Minor Repairs

Pick-Up & Delivery Available

9786 N. Government Way • Hayden, ID  
208.772.4556 • librandioutdoorpower.com

## Community Calendar

**North Idaho Early Learning Fair,** Saturday, May 16th, 9am-noon at Silver Lake Mall, 200 W. Hanley Ave., CdA. An opportunity to explore health and wellness resources, preschool and child care options, summer programs and community services. Free family-friendly event presented by United Way and North Idaho Early Learning Collaborative.

**A Lark at the State Park,** Friday, May 15th, 11am, for all ages is an outdoor program sponsored by Coeur d'Alene Library and Idaho State Parks Department at Higgins Point, east end of Coeur d'Alene Lake Drive, CdA. Celebrate birds with silly stories,

fascinating facts, bird ballads, avian activities and a free book! Allow time to hike the 1/3-mile paved trail from the parking lot up to the picnic shelter.

**North Idaho Veterans Stand Down,** 8am-1pm Saturday, May 16, 2026 at Kootenai County Fairgrounds, Jacklin Building #25. The Idaho Veterans Chamber of Commerce (IDVCC) exemplifies the spirit of giving by empowering veterans and their families across Idaho. Through comprehensive navigation services in education, workforce, housing, entrepreneurship, and family wellness, the IDVCC helps veterans transition successfully to civilian life.

Courtesy of Coeur d'Alene Insider, [cdainsider.com](http://cdainsider.com)



## Specializing in Post Frame Buildings

### RESIDENTIAL SPECIAL SIZES

**24X32X10**  
Base price starts at  
**\$23,950**

**30X60X12**  
Base price starts at  
**\$29,950**

**40X60X16**  
Base price starts at  
**\$58,450**



**30X48X16**  
Base price starts at  
**\$42,650**

**30X40X10**  
Base price starts at  
**\$29,750**

**36X36X10**  
Base price starts at  
**\$44,850**

\*Some options shown may not be included in base price.  
Prices vary depending on location due to snow load, delivery, and engineering requirements.\*

CALL TODAY

**855-MQS-BARN | 855-677-2276**

[www.mqsbar.com](http://www.mqsbar.com)

# SPECIAL ISSUE 2026



**FULL SERVICE LAWN CARE!**  
Now scheduling irrigation service & backflow testing

**Aspen LAWN CARE**

- Mowing • Fertilizing
- Bed maintenance
- Weed control • Pest control
- Shrub fertilization
- Shrub & tree nutrients

• commercial & residential  
• free estimates  
• licensed & insured

**NOW HIRING - CONTACT US TODAY!**  
208-691-8624 | [www.cdalawnservice.com](http://www.cdalawnservice.com)

## Gardening & Landscaping

**Now Booking Lawnmowing Huck-N-Stone**  
Lawn & Tree Removal • Serving North ID  
Safety • Responsiveness • Quality  
Licensed, Bonded & Insured Arborists RCT-67144

Call 208-215-6356 for Free Same Day Estimates

LIKE NEW STIHL MS271 20" chainsaw, \$465. Older 25HP Shenniu Hardy diesel 4x4 tractor with 3-point and PTO, runs good, \$6600. 3500 watt generator, \$350. Stihl MS 171 16" chainsaw, \$200. Accepting credit cards, 208-762-5651

EXPERT TREE CARE. Hazardous tree removal, wind thinning, 360 degree trimming, stump grinding, pruning, weight reduction and tree health specialist. Free estimates. Local business, licensed and insured, open 24 hours, 20+ years experience. Tree and Landscape Services LLC, 208-714-1197

ATTENTION: RAISED BED gardeners. Don't use treated lumber full of toxic chemicals. I have all natural heartwood western red cedar boards, full dimension. 2x10, any length, \$10 per lineal foot; 2x12, any length, \$12 per lineal foot. Call Nelson at 208-215-9661

SEE THE NICKEL'S Worth online at [www.nickelsworth.com](http://www.nickelsworth.com)!

FREE STRUCTURAL FILL dirt. Great for any project, just pay for delivery. Call 208-772-1883 for details



**Fort Sherman Cannon**  
by Rey's Photography



# LAWN MOWING

Hayden • Coeur d'Alene area

Reasonable • Experienced • Reliable

## WEEKLY MOWING ONLY

Free estimates  
Kosanke's Lawn Mowing Service  
**208-770-9279**

HAVE TRUCK AND trailer and am ready to work! Dump runs, yard clean up, material hauling, etc. Call Garth, 208-704-9441

CUB CADET 46" RIDING lawnmower. All new belts, excellent condition; new price \$2800, asking \$1200 OBO. 208-783-7584, Kellogg

TUNE-UP AND REPAIR ON mowers and other power equipment. Reconditioned lawnmowers from \$180 and up. Accepting credit cards. 208-762-5651

SEE NICKEL'S Worth online: [www.nickelsworth.com](http://www.nickelsworth.com)



11'-15' BLUE SPRUCE already in 50" burlap and basket, ready to load on your trailer. Prices \$700-\$900. Located in Hayden. Call 208-755-3497

Now in stock

# Zero-Turn Mowers at



We have the best zero-turn mowers in the industry today... in stock now



Mowing season is here.  
Get yours before it's gone.

(208) 765-2315 • 1112 W Appleway Ave, Coeur d'Alene, ID • [www.cdatractor.com](http://www.cdatractor.com)



# 2026 Home Improvement Special Issue



A special pull-and-save issue



## MINI SUDOKU

		4	5		
	6			4	
		2	3	6	
5					
				5	2

Place a number in the empty boxes in such a way that each row across, each column down and each small 6-box square contains all of the numbers from one to six.

## Gardening & Landscaping

**BILLY GOAT Commercial** Honda yard vacuum, \$950. Stihl SH86C Blower vac shredder, \$330. Stihl BG 400 backpack blower, \$230. Honda HRC216 21" commercial lawnmower, excellent condition, \$1350. Stihl straight shaft trimmer, \$250. Champion 7000 watt generator, \$650. Honda EB3000C inverter generator, \$1100. Nice Champion tri-fuel 10kW generator, \$1150. Accepting credit cards, 208-762-5651

**WANTED: ANY BOULDERS!** 2 to 4 feet, different species. Have equipment, will travel throughout Kootenai County. Call Aaron at 208-704-6528

**TWO GOOD FRONT TINE** rototillers, \$380 and \$490. Honda 21" lawnmower, excellent condition, \$475. Craftsman 42" lawn tractor, \$850. John Deere LX277 lawn tractor, excellent condition, \$3300. Stihl MS-251 18" chainsaw, \$350. Nice Ariens swivel wheel 21" lawnmower, \$525. Lewis portable chainsaw winch with powerhead, \$1460. 42" Craftsman lawn tractor snowblower attachment, \$1150. Accepting credit cards, 208-762-5651

**HONDA 30" RIDING** lawnmower, \$1450. DR Powerwagon gas powered wheelbarrow cart, excellent condition \$1850. Honda HS724 Track drive 2-stage snowblower, \$2250. New Toro 21" Recycler self-propelled mower, \$410. Cub Cadet ZTR 50 Zero-turn mower, works great, \$2500. 26" Troy-Bilt Storm 2-stage snowblower, like new condition, \$850. Accepting credit cards, 208-762-5651

### Movers

**TWO MOVERS AND** moving truck. Equipped with pads, dollies, etc. Load/unload rental trucks. Specializing in pianos, safes and pool tables, and other household goods. Licensed, insured, and we have workman's comp. 208-699-4631

**TORO POWER CLEAR** snowblower model 721QZE. Used twice, make offer. 208-620-0516, leave message, Post Falls

SMILE, YOU ARE GOOD

42" HUSQVARNA ZTR, nice condition, \$2750. Nice Troy-Bilt Pony rear tine tiller, \$950. Good running basic lawnmowers from \$150+. New 3500W Craftsman generator with wheel kit and RV plug, \$550. Nice HS1332 Honda track drive snowthrower, \$3250. Heavy duty 5x8 tilt trailer, \$1450. Nice Troy-Bilt horse tiller, \$1850. Rear tine Powermate rototiller, \$650. Accepting credit cards. 208-762-5651

**ATTENTION VETERANS** and active duty service members: Present your military ID or proof of membership in veterans' group at the Nickel's Worth office and get buy one get one free classified ads from that point on (ID only needed initially). Ads must run in the same week; free ad of equal or lesser value; display ads and picture classified ads do not qualify for free ads. Thank you for your service to our country!



## CUT-RITE LAWN SERVICE

Est. 1998 • Commercial & Residential



- Spring Cleanups
- Lawn Care
- Shrub & Tree Trimming
- Water Features
- Gutter Cleaning
- Pond Cleaning
- We Build Pondless Waterfalls

**You grow it, we mow it!**

**Weekly or Biweekly Service**  
Free Quotes  
*Locally Owned & Operated*

Contact us today! Jim & Wanda  
**208-920-0649 • cutritelawns.com**  
LICENSED & INSURED



## HAPPY MEMORIAL DAY FROM

- TOPSOIL
- SOIL
- BARK
- MANURE



- GRAVEL
- SAND
- ROCK
- COMPOST

208-772-1883 • nilandscapesupplies.com

Mon-Sat, 7am-5pm • Sun 9am-3pm

11631 N. Govt. Way, Hayden. Corner of Buckles & Govt. Way

We proudly offer deliveries. Call for pricing.

# NW Jr

FUN STUFF FOR KIDS TO DO!

Match each worker & truck →  
Find 10 differences ↓

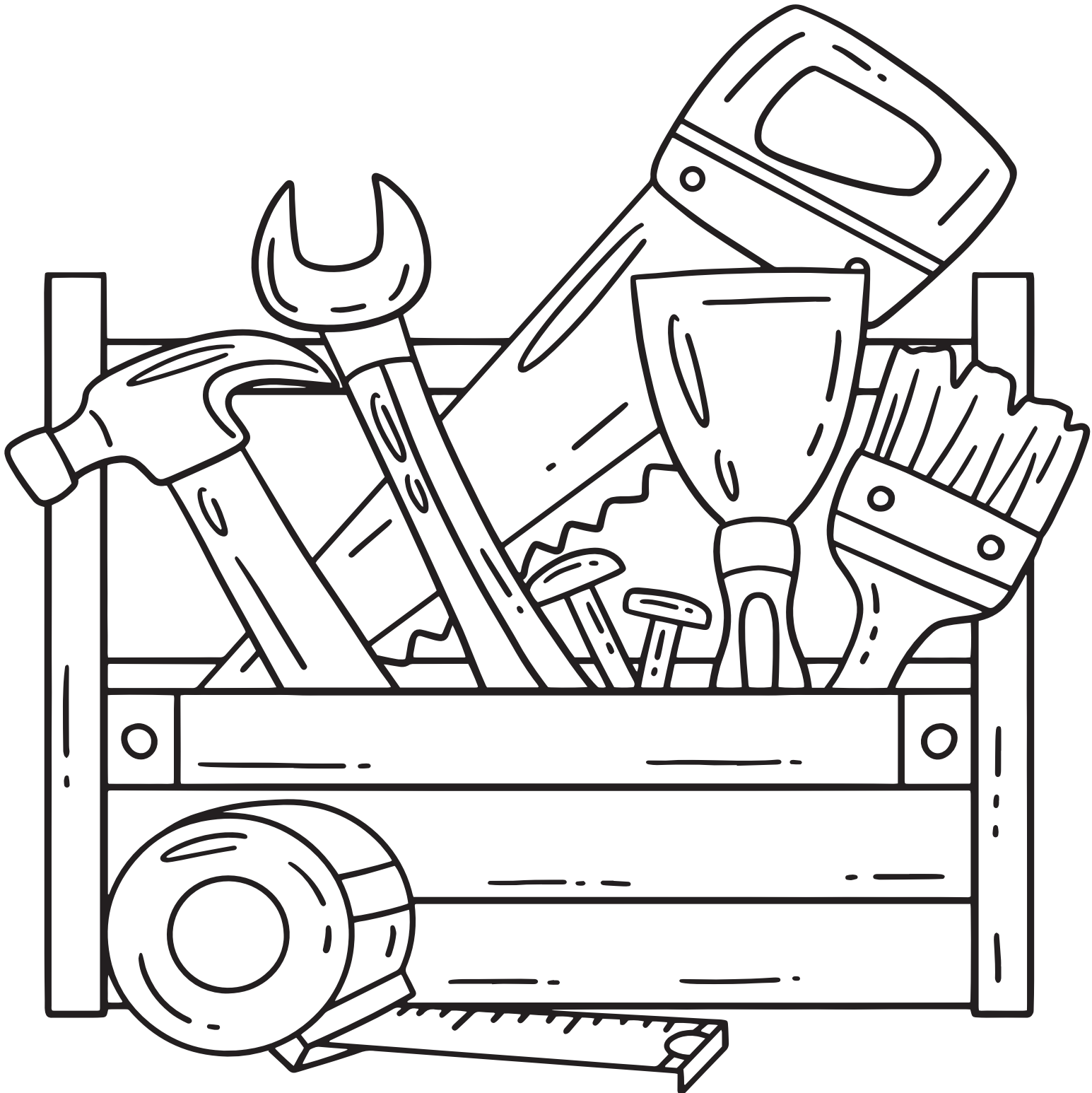
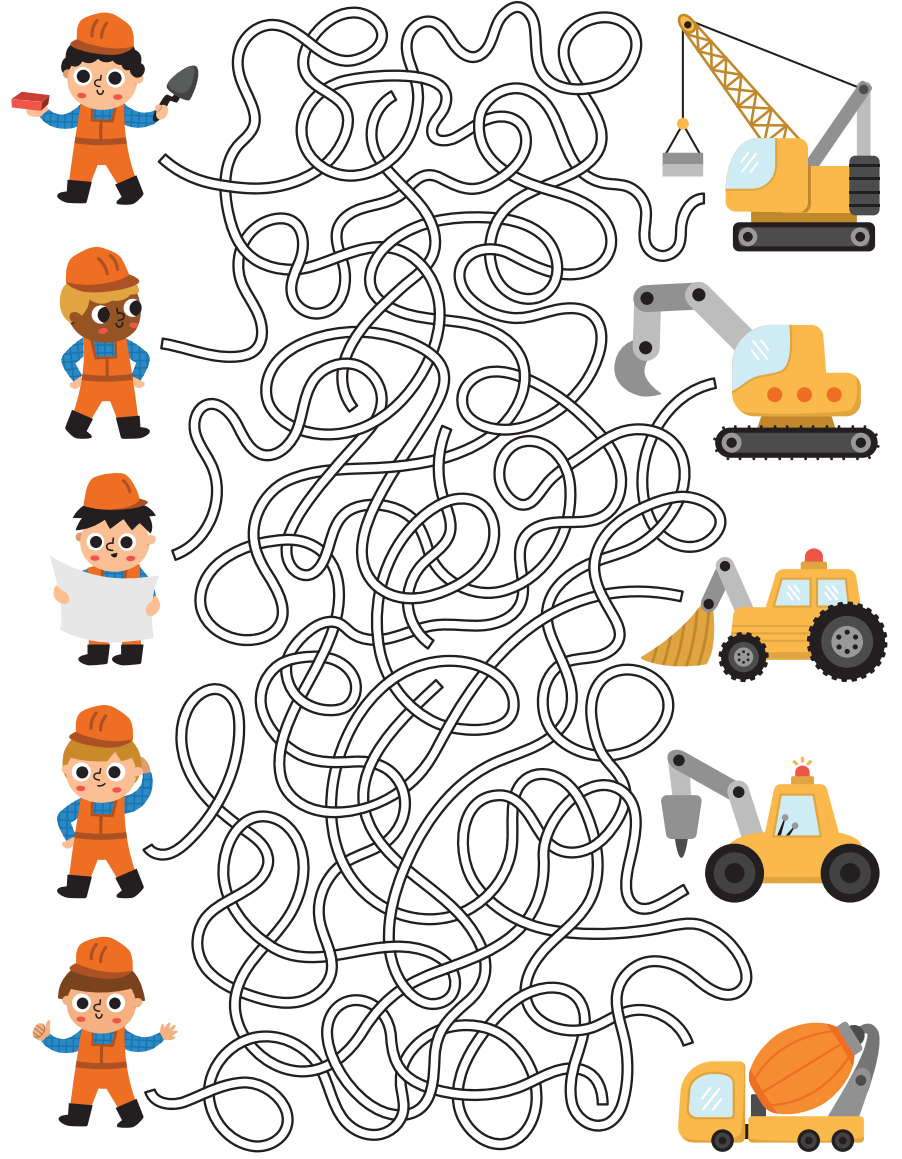
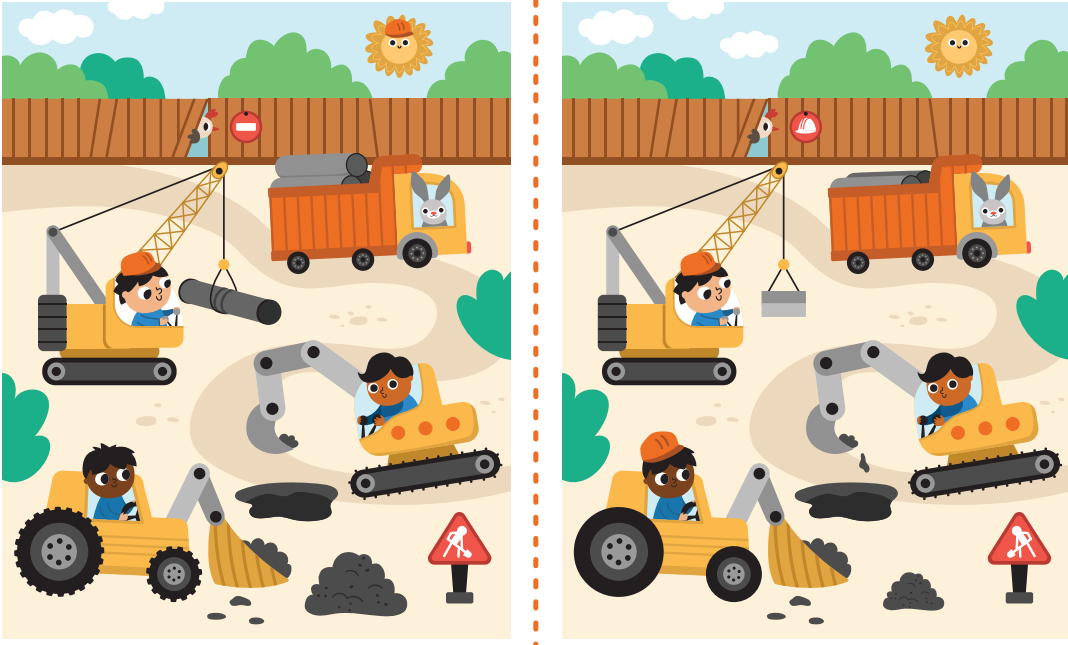

# Heavy Equipment Logging & Farm Machinery



2017 KOMATSU XT460L-3, feller buncher, Quadco 22B 360 hot saw, pre-emissions 300HP Cummins with no DEF, 10,000 hours, 85% undercarriage, \$190,000. More pictures at [www.GreatNorthernEquip.com](http://www.GreatNorthernEquip.com). Calls only, 509-535-4427, Spokane

REFRIGERATED TRAILER, 53' long, 2006 Utility, blows cold, tires, brakes and drums in excellent condition. Excellent to be used over the road or storage also, \$8300. 208-651-8698, no texts

LAND PRIDE 96" BB2596 fixed bar box scraper, \$1995. Coeur d'Alene Tractor, 1112 W. Appleway Ave., 208-765-2315



SERCO 200 LOG LOADER. Mounted on Mack carrier, \$17,500. [www.GreatNorthernEquip.com](http://www.GreatNorthernEquip.com). Calls only, 509-535-4427, Spokane



2018 KUBOTA M6-141 4WD tractor. 141HP, power shuttle, powershift, cab with heat/AC, PTO, 3-point hitch, three remotes, 14.9R24 front tires, 480/80R38 rear tires, 4570 hours. \$42,500. [www.GreatNorthernEquip.com](http://www.GreatNorthernEquip.com). Calls only, 509-535-4427, Spokane



NEED A LOGGER? SEE how much your timber is worth. Free timber value estimate. Call Jake at 208-817-9786, [www.jdforest.com](http://www.jdforest.com)

4400 PSI PRESSURE washer, \$750. Like new John Deere 2025R 4x4 25HP tractor with loader, \$25,500. Honda 21" commercial lawn mower, \$990. Honda EU3000i Handi inverter/ generator, \$1950. 3000 PSI Honda pressure washer, \$325. Honda ES6500 genset, good condition, \$2950. Credit cards accepted, 208-762-5651

BACK BLADE FOR Tractor, \$350. 509-279-3199



2016 TIMBERPRO TL745C, feller buncher. Quadco 22C 360 head, 90% undercarriage, 300HP Cummins, no DEF, 8500 hours, excellent condition. \$225,000. [www.GreatNorthernEquip.com](http://www.GreatNorthernEquip.com). Calls only, 509-535-4427, Spokane

CURTIS 96" FRONT SNOW blade, \$3295. Coeur d'Alene Tractor, 1112 W. Appleway Ave., 208-765-2315

CASE INT'L WHEEL tractor, 245HP, pre-DEF, 2750 hours, 4WD, has duals available, \$95,000. 208-651-8698, no texts

NICKEL'S WORTH PRINTS 26,000 copies weekly. Did you know that over 60,000 people read the Nickel's Worth every week? And that does not include our weekly online readers who view our electronic edition. Do you have something to sell? What are you waiting for? Contact us today to place your ad. 208-667-0651, or go to: [www.nickelsworth.com](http://www.nickelsworth.com). These statistics provided by an independent audit conducted by the Circulation Verification Council



**Bell** TIMBER, INC.  
SINCE 1909

**Buying Western Red Cedar Poles**

For prices please contact:

---

Jake Barnett  
(509) 675-4141
Dan Duley  
(208) 755-0784
Jason Betz  
(509) 671-5185

Office (208) 437-4115

# Super Crossword

## REGRESSION ANALYSIS

### ACROSS

- 1 Bourbon brand
- 8 Belly area
- 15 Girlfriend, in Genoa
- 20 Pertaining to the womb
- 21 Spiced Starbucks selection
- 22 Autos for test-driving
- 23 Food, clothes or money [actress Danes]
- 25 Greek market of old
- 26 DC-10, e.g.
- 27 Lariat feature
- 28 Rushes about wildly
- 30 Marketed
- 31 Grain tower
- 32 Like a skimpy swimsuit [actor Perry]
- 35 Church area
- 37 Powders mixed into liquids, e.g.
- 38 Research ctr.
- 39 Shoes worn with tutus [designer McCartney]
- 44 Tenth mo.
- 46 Perjurer's confession
- 47 Fork prong
- 48 Pop singer Rita
- 49 Mai — (drink)
- 52 Young morays, say
- 54 Huge Asian mammal [justice Kagan]
- 60 Tijuana-to-Vegas dir.
- 61 Add- — (extras)
- 63 Olive — (military uniforms)
- 64 Small lakes
- 65 — Jima
- 67 Having supple arms and legs [jazzman Davis]
- 72 Nuptial vow
- 73 Moving spryly
- 75 Smoothly polite
- 76 Neighbor of TV's Homer
- 78 Surg. sites
- 80 Roomy place to house vehicles [actress Jones]
- 85 Vacation spot
- 87 Swallowed
- 88 Little fellow
- 89 Performs like Ice Cube
- 91 Initial venture
- 92 1040 info

### DOWN

- 1 Vaults
- 2 Writer
- 3 Lead or tin
- 4 "I'm Sorry" singer
- 5 The Emerald Isle
- 6 Singer DiFranco
- 7 Most soft, dry and crumbly
- 8 "Solid Gold" host Marilyn
- 9 Breakfast chain, for short
- 10 Flow barrier
- 11 Discharge from the military, informally
- 12 Skater Midori
- 13 Minks' kin
- 14 Femme —
- 15 Modify
- 16 #1 song, say
- 17 "The Father" actress Poots
- 18 Tools for fruit preparation
- 19 How bedding is often packaged
- 24 IM chuckle
- 29 City near Bangalore
- 31 Booming jet of old, in brief
- 32 Jazz genre
- 33 Bitter brew
- 34 Karel Capek sci-fi play
- 36 Actor Pascal
- 37 Floored it
- 93 Small, springy apparatus [director Scorsese]
- 98 Zenith
- 101 Almsgiving
- 103 Othello's false friend
- 104 Antipollution law [singer Grande]
- 106 — -Alt-Del
- 108 Major- — (butler)
- 112 Gives one's approval
- 113 Persia, today
- 114 Showed anew
- 115 Ellipses
- 116 What the eight featured celebrities in this puzzle are doing?
- 121 Edit further, perhaps
- 122 State of joy
- 123 Bones near tibiae
- 124 Bottom-of-barrel residue
- 125 Fabray of Broadway
- 126 Greek Week guy

- 39 Good, in Nice
- 40 From dusk to dawn
- 41 Dynamo
- 42 52, to Flavius
- 43 Hotel cousin
- 45 Li'l Abner creator Al
- 48 Ashley or Mary-Kate
- 49 Cooked in a clay oven, as naan
- 50 Neighbor of a Spaniard
- 51 Part of TGIF
- 53 NBC skit show, in brief
- 55 Lazy sort
- 56 Meyers of "Kate & Allie"
- 57 "Rambo" site, for short
- 58 Decline
- 59 — polloi
- 62 "What a pity!"
- 66 Bullfight yell
- 68 Your and my
- 69 Droop down
- 70 Mendes of movies
- 71 Berlin article
- 73 — discount
- 74 Long, thin fish
- 77 Clear of mist
- 79 Eye sore
- 81 High-kicking French dance
- 82 Dilettantish
- 83 Long, thin fish

- 84 Org. enforcing the 104-Across
- 86 First post-band album, perhaps
- 90 Vodka brand
- 92 Marine snail with no shell
- 93 Cooking wine
- 94 Lyricist Gershwin
- 95 Actor Cage, to friends
- 96 "Addams Family" cousin
- 97 Compadre
- 98 Harmony
- 99 Shamrock, e.g.
- 100 Threat
- 102 Guys contracted by the Mafia
- 105 Bird hangouts
- 106 Wading bird
- 107 Tic — (mint)
- 109 Toothbrush brand
- 110 Region of China
- 111 In tune
- 113 "— Rhythm"
- 114 Country's McEntire
- 117 Mo. neighbor
- 118 Native suffix
- 119 Tiny objection
- 120 Space station until 2001

1	2	3	4	5	6	7	8	9	10	11	12	13	14	15	16	17	18	19			
20							21							22							
23							24							25							
26						27						28		29							
30						31				32	33	34									
			35	36						37							38				
39	40	41					42	43						44	45						
46							47						48				49	50	51		
52						53		54		55	56	57	58				59				
60						61		62					63				64				
	65		66			67		68	69	70					71		72				
73				74		75								76		77		78	79		
80						81					82	83	84		85		86				
87						88					89			90		91					
						92				93	94	95	96				97				
98	99	100				101	102							103							
104						105							106	107				108	109	110	111
112													113					114			
115																					
121																					
124																					



©2026 King Features Syndicate, Inc. All rights reserved.



# BUYING CEDAR LOGS

Delivered to Naples, ID & Swan Lake Landing, St. Maries, ID  
Now also delivering to Port of Lewiston, ID

TREVOR FAVARO | LUKE MACHTOLF, CF  
208-290-4547 | 509-867-6313



## Heavy Equipment Logging & Farm Machinery



**Eagle Manufacturing**  
The Trailer People

Custom Built Trailers  
Trailer Repair & Parts  
We Service Boat Trailers  
Trailer Inspections  
Steel Sales

**LICENSED WELDING**

- Steel, Aluminum & Stainless
- Pack Bearings • Repair Wiring
- Hitches, Sandblasting & Snowplows

208-687-1019 • EagleMfg2015@gmail.com  
6570 W. Willadsen Rd 1 mile north of Rathdrum

(4) 13.00x24 TITAN E3/L3 12-ply, \$1300. 208-699-2196, Sagle



2017 KOMATSU XT445L-3, feller buncher, Quadco 24B 360 hot saw, pre-emissions 300HP Cummins with no DEF, 6400 hours, excellent condition, \$260,000. More pictures at www.GreatNorthernEquip.com. Calls only, 509-535-4427, Spokane

WE WORK ON HEAVY equipment and farm tractors. Dave's Truck & Equipment, 208-263-3555

OLDER 25HP SHENNIU Hardy diesel 4x4 tractor with 3-point and PTO, runs good, \$6600. 3500 watt generator, \$350. Stihl MS 171 16" chain-saw, \$200. Craftsman 5500 portable generator, \$660. Accepting credit cards, 208-762-5651

KUBOTA 60" LX2980 Commercial front snowblower attachment with hitch and mid-PTO drive, \$6700. Coeur d'Alene Tractor, 1112 W. Appleyway Ave., 208-765-2315

GOOD CONDITION JOHN Deere 4105 4x4 tractor, 42 HP diesel with front loader, \$28,500. Honda ES6500 liquid cooled generator, works good, \$2500. New 72" hydraulic grapple bucket with skid steer quick attach, \$2850. DeWalt Honda wheelbarrow air compressor, works good, \$950. Accepting credit cards, 208-762-5651

JOHN DEERE 10' DISC, \$2000. 14' John Deere disc with tandem axles, \$4000. 14' JD Cultipacker, \$4000. Rosserhead debarker for debarking logs or can be converted into pole peeler, \$12,000. Yates A-62 planer, \$12,000. OBO everything. 778-963-0428, Idaho border



1996 CAT 527, 8-ROLLER machine. Escro 210 swing grapple, 80% undercarriage, 16,000 frame hours, recent CAT transmission, \$150,000. Very nice 527 for the hours. www.GreatNorthernEquip.com. Calls only, 509-535-4427, Spokane

KUBOTA BX2822A Commercial front snowblower attachment for Kubota B2601 tractor, \$5500. Coeur d'Alene Tractor, 1112 W. Appleyway Ave., 208-765-2315

## Trivia test by Fifi Rodriguez

1. HISTORY: Which country sold Alaska to the United States?
2. GEOGRAPHY: On which continent is the Sahara Desert?
3. GENERAL KNOWLEDGE: Who created The Muppets?
4. MUSIC: What was singer Miley Cyrus' alter ego when she starred in a Disney sitcom?
5. MATH: How many sides does a heptagon (sometimes called a septagon) have?
6. MOVIES: Which singer is featured in the biopic "A Complete Unknown"?
7. FOOD & DRINK: What is carpaccio?
8. LITERATURE: In "The Jungle Book," who raised the boy called Mowgli?
9. TELEVISION: Where was Mork from in the sitcom "Mork and Mindy"?
10. LANGUAGE: What does the phrase "doubleplusungood" mean in Newspeak, featured in the dystopian novel "1984"?

- Answers**
1. Russia, in 1867.
  2. Africa.
  3. Jim Henson.
  4. Hannah Montana.
  5. Seven.
  6. Bob Dylan.
  7. Thinly sliced raw meat or fish, usually served as an appetizer.
  8. Wolves.
  9. Planet Ork.
  10. Terrible.

GET YOUR QUOTE FOR undercarriage parts from Dave's Truck & Equipment, 208-263-3555

FREE STRUCTURAL FILL dirt. Great for any project, just pay for delivery. Call 208-772-1883 for details



2000 JOHN DEERE 650G TC, long track. 2760 original hours, John Deere 4000 winch and WBM arch, torque convertor, \$80,000. www.GreatNorthernEquip.com. Calls only, 509-535-4427, Spokane

LAND PRIDE 84" HR3584 hydraulic box scraper, \$4195. Coeur d'Alene Tractor, 1112 W. Appleyway Ave., 208-765-2315

2007 NEW HOLLAND TC-30 tractor with front loader, 4x4, great shape, \$15,000. Text or call 208-603-8095 or 208-946-0812, Libby, MT

GRAVELY AXIS STAND-ON track loader with 36" bucket for \$19,995. Coeur d'Alene Tractor, 1112 W. Appleyway, Ave., 208-765-2315



2013 JOHN DEERE 2454D processor with Waratah 623C head, TimberRite computer, 14,000 hours, 75% undercarriage, \$70,000. www.GreatNorthernEquip.com. Calls only, 509-535-4427, Spokane



2020 JOHN DEERE 848L-II skidder, 5400 hours, double diamond chains, 30.5x32 tires at 60%, \$160,000. www.GreatNorthernEquip.com. Calls only, 509-535-4427, Spokane

1984 MACK SUPERLINER dump truck. E9 500HP motor is tired, good box and cylinder, 46 lb. rear ends, 10-speed transmission. \$7000, you haul. Need it gone! 509-953-4621

NEW HOLLAND Workmaster 25 4x4 tractor with hydrostatic transmission, 1 pair rear remotes, front loader with quick attach. Low hours. \$19,900. Coeur d'Alene Tractor, 1112 W. Appleyway Ave., 208-765-2315

(3) LOADER TIRES 20.5R25, 1 new, 2 at 80%, \$2400. 208-699-2196, Sagle, ID



2000 JOHN DEERE 772CH grader. Cab with heat and AC, 14.00x24 radial tires at 50%, 14' MB, front bull blade, recent transmission from JD, 11,500 hours, excellent condition, \$52,500. More pictures at GreatNorthernEquip.com. Calls only, 509-535-4427, Spokane

MASSEY HESSTON BALER Model 1838 small square inline. Like new, only 12,000 bales, \$20,000. Ed, 208-659-3840

DR DRAGON PRODUCTS box scraper, \$500. Coeur d'Alene Tractor, 1112 W. Appleyway Ave., 208-765-2315

## Employment

CDA RIFLE AND PISTOL Club is seeking a Caretaker/Range Safety Officer. Duties include: conducting safe and effective live fire range operations and coordination, repairing/ replacing target holders, cleaning and maintaining firing lines/ positions, accepting and processing membership applications, range fees and monies generated and additional duties as outlined in the official Club Caretaker duties. Experience around firearms and military/ law enforcement background preferred. NRA Range Safety Officer and current range training available. Forty hour work week, pay/ compensation is negotiable. Includes one bedroom, one bath apartment on premises. Text Jim at 540-907-8875 or Jimmie at 208-659-7922

**VOLUNTEERS NEEDED!** Cook, dishwashers, servers. Join the fun kitchen crew in preparing and serving meals at the Post Falls American Legion. Multiple shifts available. Apply online at pfp143.org/volunteers or call the Legion office at 208-773-9054

**CAREGIVER LOOKING** for job in Sagle, Sandpoint, and surrounding areas. No heavy lifting, good at all things in-house; multiple years experience, have references. 208-518-7956

**EXPERIENCED MID/** Heavy duty diesel technician wanted! Wage DOE: \$25-\$35 hour. Full time Monday-Friday, full benefit package. Must be a capable independent worker, diagnostic adept, Cummins experience (preferred), proficient in reading and writing. Call 208-263-4643, email brownscouter@gmail.com, Bonner County

**IN SEARCH OF FULL-TIME** logger choker setter, line machine operator, and processor operator. Great work ethic and positive attitude required. Compensation depends on experience, all wages pay very well and increase with experience. 406-396-7406, see photos at www.nickelsworth.com

## Fairway Floor Inc.



## Abby Carpet & Floor

LICENSED CARPET, VINYL and tile installers needed! Busy flooring store looking to add new sub-contractors for the Inland Northwest area. Start today! We offer competitive rates, call 208-777-7711

**WILL HIRE A COMPANION** or someone who will give rides around the town, 208-415-2128

**CONCRETE WORKERS** needed. No experience necessary for laborers or finishers, own tools and transportation a must. Starting at \$25, up to \$37 hour DOE. Health and dental, paid vacation, earned monthly bonus. Contact Allen Hyslop, 208-277-7500

**HIRING LAWN** maintenance and landscape technician, experience preferred but not necessary. Competitive wages. Call/ text, 208-819-2667

**COMFORT KEEPERS** urgent hiring full-time/ part-time caregivers, \$17.50-\$19 DOE. Coeur d'Alene, Hayden, Post Falls, Rathdrum, Blanchard. Flexible shifts. Assist with daily living, light housekeeping, meals, personal care and mobility. Valid driver's license, auto insurance, background check required. Experience helpful, training provided. Apply: ckl25.ersp.biz/employment

NICKEL'S WORTH advises everyone to use caution when responding to employment listings. All employment inquiries should be free; if you have to pay to request information regarding a job opportunity, there's a good chance it's a scam

## Health & Fitness



**Nurse Next Door**  
home care services  
nursenextdoor.com

NURSE NEXT DOOR provides skilled nursing, physical therapy, wound care, and home care. Veterans, ask your doctor about HHA Program through VA for free services. Accepting TriWest, Medicare, Blue Cross. Contact us at 208-600-1899

**POWER WHEELCHAIR**, Jazzy Elite HD, new. \$1500, 208-699-2196, Sagle



**NATIONAL SUICIDE PREVENTION LIFELINE**  
1-800-273-TALK (8255)  
suicidepreventionlifeline.org

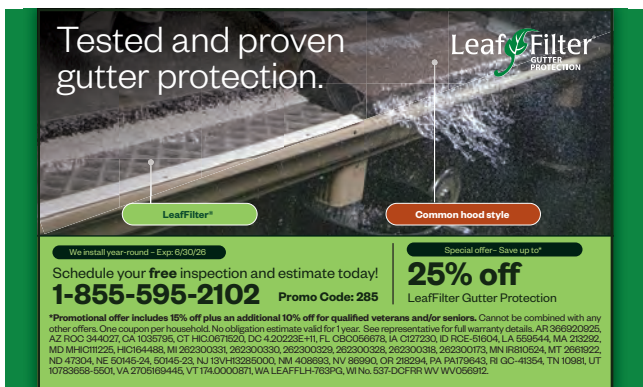

Tested and proven gutter protection.

LeafFilter Gutter Protection

We install year-round - Exp. 8/2026

Schedule your **free** inspection and estimate today!  
**1-855-595-2102** Promo Code: 285

Special offer - Save up to! **25% off** LeafFilter Gutter Protection

\*Promotional offer includes 15% off plus an additional 10% off for qualified veterans and/or seniors. Cannot be combined with any other offers. One coupon per household. No obligation estimate valid for 1 year. See representative for full warranty details. AR 369520026, AZ 800-344027, CA 1035795, CT 4100767620, DC 420223E-H1, FL 350066678, IA C127230, ID R0E-8904, LA 595644, MA 253592, MD 410-817225, MI 616-4488, MN 26230-0331, 26230-0330, 26230-0329, 26230-0328, 26230-0326, 26230-0325, 26230-0324, 26230-0323, 26230-0322, ND 47304, NE 50446-24, 50445-23, NJ 574-3285000, NM 4086903, NV 869900, OR 2629294, PA PA179643, RI GC-49354, TN 10081, UT 10783668-0501, VA 270869446, VT 774-0000871, WA LEAFFL-H-763P3, WI No. 637-DCFFR HV WV056902.



**Computer on the fritz?**  
We'd be glad to take your ad over the phone.  
Call the Nickel's Worth at 208-667-0651.

## Automobiles

**TK AUTO Sales**  
**509-242-3588**  
 tkautosalespokane.com  
 6904 E. Sprague  
 Spokane Valley, WA  
**FINANCING AVAILABLE OVER 275 VEHICLES IN STOCK**



2004 SUBARU LEGACY Outback AWP. Automatic, 4-cylinder, 107,388 actual miles, AWD, \$4997. Mechanic inspected, no codes. Easy financing, in-house available. Three-month or six-month warranty on select vehicles. Extended warranty available. Good Miles Auto Sales, 509-993-8239

We do it right the first time and stand behind our work with a written guarantee.  
 (208) 457-4040  
 M-F 7am-5pm  
**SCOTT SHAWVER'S AUTO BODY & RV**  
 2915 E. SELTICE WAY - POST FALLS

CLEAN 2003 BUICK LeSabre, 175K miles, runs good, Price reduced to \$1500 OBO. 208-661-3043 to view



2009 NISSAN ALTIMA, FWD, CVT, 4-cylinder, 124,684 miles, \$4577. Mechanic inspected, no codes. Easy financing, in-house available. Three-month or six-month warranty on select vehicles. Extended warranty available. Good Miles Auto Sales, 509-993-8239

NICKEL'S WORTH PRINTS 26,000 copies weekly. Did you know that over 60,000 people read the Nickel's Worth every week? And that does not include our 2500 weekly online readers who view our electronic edition. Do you have something to sell? What are you waiting for? Contact us today to place your ad. 208-667-0651 or go to: www.nickelsworth.com. These statistics provided by an independent audit conducted by the Circulation Verification Council

COLLIGAN'S AUTO Service, 208-889-9547, 5250 E. Seltice Way, Post Falls. Colligan's Auto Service is now offering \$99 hourly shop rate for a limited time! Call for an appointment today!



BMW 330i, LOW MILES, new tires, turbo, sunroof, heated leather seats, back up camera, power windows, stored in the winters, \$15,000. Call 208-651-4600, Athol, ID

WILL PICK UP unwanted cars and trucks free. 208-263-4639



2014 HONDA ACCORD Sport, near perfect condition, 33,110 miles, just detailed, great grad gift, \$18,000. 208-755-0318

COLLIGAN'S AUTO Service, 208-889-9547, 5250 E. Seltice Way, Post Falls. We're offering a free computer system scan! Domestic and Asian cars and trucks. Limited time offer! Come in today!

PLACE YOUR NICKEL'S Worth ad online at www.nickelsworth.com

2019 CHEVY EQUINOX LT, 4-door SUV. AWD, 62,700 miles, one owner, \$16,799. Includes studded snow tires (like new) on rims. Call for information/ pictures, 208-859-0511

DONATE YOUR CAR to veterans today! Help and support our veterans. Fast, free pick up. 100% tax deductible. Call 800-245-0398

1977 VOLKSWAGEN Beetle, 1600cc engine, runs great, well cared for. 208-699-3636



2012 SUBARU FORESTER 2.5X Premium, SUV. Automatic, 4-cylinder, AWD, 174,000 miles, \$4977. Mechanic inspected, no codes. Easy financing, in-house available. Three-month or six-month warranty on select vehicles. Extended warranty available. Good Miles Auto Sales, 509-993-8239

## Afterglow of the Revolution

— Timothy Linton —

Neon eyes  
 Turbulent.  
 My infatuation runs together,  
 Collected in dew drops  
 Streaming into a current.  
 The waking from a long dream.  
 I saw you in a grocery story  
 And it its organized depths  
 I plumbed your heart's depth  
 And for a brief scandalous moment  
 I tasted a taste of death.  
 We stepped out of body  
 Out of place  
 Memory.  
 Iron  
 Too cold and old to bend or break  
 But your love can make the levy quake.  
 I held you in my arms.  
 And I could swear I felt you melt.

Copyright 2026 Timothy Linton

All Rights Reserved



## Classic Vehicles Antique & Special Interest

1928 STUDEBAKER Dictator, 77K miles, complete, not running, needs restoration, \$7000. 208-818-7054

1999 HARLEY-DAVIDSON custom Softail with 40th Anniversary 110 S&S motor and aftermarket Arlen Ness parts, \$7000 OBO. 208-699-2630



1950 MERCURY CLUB Coupe. Flathead V8 with Offenhauser heads. Updated Holley 4bbl carburetor on aluminum intake. 3-speed column shift manual transmission with overdrive. Gorgeous metallic maroon exterior finished with tuck and roll upholstery, \$40,000. www.GreatNorthernEquip.com. Calls only, 509-535-4427, Spokane

OLDER CAR REPAIR specialist and carburetor expert. Call Dennis, Mobile Auto Tech, 208-704-1565

1964 FORD FAIRLANE! Call for info, 208-304-4016, Bonners Ferry, ID

1967 RAMBLER REBEL, full restoration. It was AMC machine pre-1968 AMC machines. Also have 1940 Plymouth, long NHRA history of this car comes with it. Call 208-304-4016 to make appointment for viewing. Please do not text! Bonners Ferry

1951 DODGE Meadowbrook, very nice original car. Flathead six with semi-automatic fluid drive gyromatic transmission, one family owned since 1972, 33,000 miles, \$14,500 OBO. 208-755-6656



1988 CHEVROLET Camaro T-top, vintage stock, 305 V8 with automatic overdrive, new black paint with gold trim, new tires, new brakes. Been in the family for thirty years. \$8500. 208-818-0771, Kootenai County

1966 FAIRLANE 4-DOOR, \$2500 OBO. 1979 Chevy 3/4 ton, 2WD, \$1200. Four old tractors, lots of misc. 208-507-1211, Moyie Springs area

1953 WILLYS, TITLE, runs, \$5000 OBO. 208-245-1827



1972 TOYOTA FJ40, RUNS and drives great, very good overall condition, \$19,500 OBO. 208-255-4485

MINI SUDOKU  
 Answer

3	2	4	5	1	6
1	6	5	2	4	3
4	1	2	3	6	5
5	3	6	4	2	1
2	5	1	6	3	4
6	4	3	1	5	2

get your NICKEL'S WORTH

# PLANTING GUIDE

A HANDY DANDY HOW-TO CHART FOR LOCAL VEGGIE GARDENING, PRINTED ON NICE, GLOSSY PAPER. WHEN AND WHERE TO PLANT, PLUS HELPFUL TIPS AND TRICKS FOR A VARIETY OF FRUITS AND VEGGIES

**ONLY \$3.00**

AVAILABLE AT THE NICKEL'S WORTH OFFICE  
 107 N. 5TH STREET, CDA • 208.667.0651  
 (WE CAN MAIL IT, JUST ADD \$1.50)

## Recreational Vehicles

2011 FOREST RIVER Surveyor Eco Lite Edition, double axle, SP275 trailer with stabilizer jacks, well taken care of, \$8200. 208-661-1909



2016 19R FOREST RIVER Grey Wolf trailer. Like new. Natural interior decor, foot flush toilet, power awning, stabilizer jacks. Excellent condition. \$14,500. Pictures at www.lakervinc.com/forsale byowner. 208-603-7384

2022 25 FT. COACHMEN Freedom Express, pull trailer, like new. Lots of extras included, always garaged. \$29,000, call 406-293-2788 for details

22' ARCTIC FOX TRAILER model 22H, excellent condition. Fully insulated 4-seasons camper with forced air heat/ cooling, fully self-contained, new tires, some camping gear included. Never stored outside and very low miles. \$12,500. 208-704-0174

RV SERVICE TECHNICIAN available for service and repair on all makes and models of RVs. Time to summerize and get ready for summer! We also transport and relocate RVs of all types. 30 years experience; fast, professional service, reasonable rates. Please call 208-783-5229

2016 FLAGSTAFF BY Forest River Shamrock M-183 hybrid, super clean, 1/2-ton towable. JD Power average retail value \$11,250. Being offered for auction at Post Falls Auto Auction, 1094 N. McGuire Rd., Post Falls, Idaho 83854 on 05/16/2026. Call 208-457-3091

2020 HIDEOUT 21' 179LHS. Dinette slide, front walk-around RV queen bed, rear bath, used 3 times, \$13,000 OBO. Post Falls, 208-818-1664

BLACK SHEEP SPORTING Goods. Home of the lowest prices on all things outdoors. In the Silver Lake Mall, 200 W. Hanley, Cda. 208-667-7831; www.BlackSheepIdaho.com

2014 25' COLEMAN CAMP trailer, all-American theme, stainless table top, \$10,200 OBO. Calls only, no texts, 208-819-0526

2001 30' HOLIDAY Rambler Presidential. Must see! New interior paint, LED lighting, ceiling fan, AC unit. Recently replaced LVP flooring, sealed roof. Tires 80%, Anderson hitch, very good condition. We don't use it. \$10,000 OBO. 801-710-7645, De Borgia, MT

We do it right the first time and stand behind our work with a written guarantee.  
 (208) 457-4040  
 M-F 7am-5pm  
**SCOTT SHAWVER'S AUTO BODY & RV**  
 2915 E. SELTICE WAY - POST FALLS

## Parts, Accessories & Auto Services

PARTING OUT 1950 CHEV 4-door. Parting out 1951 Chev 4-door. Calls only, no text: 208-582-2699, Plummer

OLDER CAR REPAIR specialist and carburetor expert. Call Dennis, Mobile Auto Tech, 208-704-1565

## Super Crossword

J	I	M	B	E	A	M	I	D	R	I	F	F	A	M	I	C	A				
U	T	E	R	I	N	E	C	H	A	I	T	E	A	D	E	M	O	S			
M	A	T	E	R	I	A	L	C	O	M	F	O	R	T	A	G	O	R	A		
P	L	A	N	E	L	O	O	P	R	A	M	P	A	G	E	S					
S	O	L	D	S	I	L	O	B	A	R	E	L	Y	T	H	E	R	E			
	A	P	S	E	S	O	L	U	T	E	S	I	N	S	T						
B	A	L	L	E	T	S	L	I	P	P	E	R	S	O	C	T					
I	L	I	E	D	T	I	N	E			O	R	A	T	A	I					
E	L	V	E	R	S	I	N	D	I	A	N	E	L	E	P	H	A	N	T		
N	N	E	O	N	S			D	R	A	B	S	P	O	N	D	S				
I	W	O	L	O	S	E	L	I	M	B	E	D	I	D	O						
A	G	I	L	E	S	U	A	V	E		N	E	D	O	R	S					
T	H	R	E	E	C	A	R	G	A	R	A	G	E	R	E	S	O	R	T		
A	T	E	L	A	D			R	A	P	S		F	O	R	A	Y				
		S	S	N		M	I	N	I	T	R	A	M	P	O	L	I	N	E		
A	C	M	E		C	H	A	R	I	T		I	A	G	O						
C	L	E	A	N	A	I	R	A	C	T		C	T	R	L		D	O	M	O	
C	O	N	S	E	N	T	S			I	R	A	N		R	E	R	A	N		
O	V	A	L	S		M	A	K	I	N	G	A	C	O	M	E	B	A	C	K	
R	E	C	U	T		E	L	A	T	I	O	N		F	I	B	U	L	A	E	
D	R	E	G	S		N	A	N	E	T	T	E		F	R	A	T	B	O	Y	

AM I OKAY TO DRIVE?

BUZZED DRIVING IS DRUNK DRIVING



# Four Wheel Drives



2007 PEARL WHITE F-150 Lariat 4x4, 1 owner, very clean with 141 highway miles, sprayed-on bedliner, WeatherTech top, new rims and tires, comes with snow tires mounted on original rims, \$9700. 208-304-6124, Priest River, ID

2005 FORD SUPER DUTY F350 4x4 crew cab long bed, 6.0 diesel, needs some work; has winch and snowplow, 350K miles, \$8850. 208-762-5651



2001 FORD F250 SUPER Duty, extended cab, 4x4, automatic, XLT, AC, 7.3 diesel, 165,000 original miles, very clean pickup truck, \$20,000. More pictures at www.GreatNorthernEquip.com. Calls only, 509-535-4427, Spokane

BLACK SHEEP SPORTING Goods. Home of the lowest prices on all things outdoors. In the Silver Lake Mall, 200 W. Hanley, CdA. 208-667-7831; www.BlackSheepIdaho.com



1986 USED CHEVY S10 4x4. Front end damaged, would make a nice fixer upper for a teen. \$1800 OBO. Please call for information, 208-304-3040

Approving everyone everyday!

**AUT**  
CREDIT SALES.COM

HAYDEN, ID.  
208-772-7000

15047 N. GOVT WAY, HAYDEN



COLLIGAN'S AUTO Service, 208-889-9547, 5250 E. Seltice Way, Post Falls. We're offering a free computer system scan! Domestic and Asian cars and trucks. Limited time offer! Come in today!

# FLASH BACK

POP, ROCK & SOUL TRIVIA BY MICK HARPER

1. Name the singer-songwriter who first released "Reason to Believe."
2. Paul McCartney wrote the theme song for which James Bond film?
3. Who wrote and released "Stand By Me"?
4. What was REO Speedwagon's first big hit?
5. Name the song that contains this lyric: "When I think about those nights in Montreal, I get the sweet thoughts of you and me."

**Answers**

1. Tim Hardin, in 1965. Since then, the song has been widely covered, including by Rod Stewart, Bobby Darin and Marianne Faithfull. The song was included on the soundtrack for the film "Wonder Boys" in 2000.
2. "Live and Let Die," in 1973.
3. Ben E. King, in 1961. King's chart-topper has been covered at least 500 times. It was used in the soundtrack of the film of the same name in 1986 and was included in the list of 500 Greatest Songs of All Time.
4. "Keep on Loving You," in 1980.
5. "I Just Wanna Stop," by Gino Vannelli, in 1978. The song was Vannelli's biggest hit, topping the charts in Canada. He got his first break when he ran after Herb Alpert across an L.A. parking lot to give him a demo tape.

# Pickups & Vans



1999 FORD F-250. V-10, 142K miles, auto transmission, 4x4, 8' Rhino lined bed with flip back cover, AC, power doors and windows, cruise, trailer mirrors, seat covers, new headliner, aluminum wheels, tires 90%+, front and rear work lamps, new head and turn signals, very well maintained. \$11,000 OBO. Keith, 208-964-2634



2006 DODGE DAKOTA Quad SLT, 6-month warranty. 4WD automatic, 8-cylinder, 171K miles, \$5277. Mechanic inspected, no codes. Easy financing, in-house available. Three-month or six-month warranty on select vehicles. Extended warranty available. Good Miles Auto Sales, 509-993-8239

ONLINE at nickelsworth.com

# Utility Trailers

EAGLE IRON TRAILER. 10'x5', newer tires and a brand new spare, good condition, 2" ball hitch, \$1200. 360-239-8087, Bonners Ferry



LOWEST PRICED TRAILER in Northwest. 14,000 GVW, 22' deck with 14-ply tires gross 17,500 GVW, free spare, regularly \$8995, sale \$6275. M&M Trailers, 39 years. Stevensville, MT. www.mmmissoula.com or mikehalvorson@hotmail.com, 406-728-1000

BIG TEX 2021 TRAILER, single axle, 77"x10' with ramp gate, use for hauling side-by-side, \$2200. 208-762-1530, Kootenai County

10.5x6x6 ENCLOSED trailer, partially converted to camp trailer, \$5100. 6x10 steel trailer with side rails and loading gate, \$2350. Older 6.5x14 dual axle flatbed trailer, \$1650. 5.5x8 high clearance military utility trailer with racks, \$2350. 4.5x10 steel tilt trailer, \$1350. Brand new galvanized 4.5x7.5 tilt trailer, \$2450. Electric trailer mover dolly, \$850. Nice tow dolly, \$2350. Accepting credit cards, 208-762-5651

CIRCLE B TRAILERS Sales & Barns: Utility, cargo, car hauler and stock. Bonners Ferry, ID, 208-267-0704; 208-290-4616; circlebtrailers.com



2013 INTERSTATE 20 TON dovetail equipment trailer. 34' overall length, 22' flat, 6' tongue, 6' tail with 6' ramps, hub pilot wheels with 17.5 tires, air brakes, new deck, excellent condition, \$20,000. www.GreatNorthernEquip.com. Calls only, 509-535-4427, Spokane



LOWEST PRICED TRAILER in Northwest. 10,400 GVW, 22' deck with 10-ply tires gross 14,000 GVW, free spare, regularly \$7495, sale \$5495. M&M Trailers, 39 years. Stevensville, MT. www.mmmissoula.com or mikehalvorson@hotmail.com, 406-728-1000

TRAILER HITCH PINS, 5/16", 251 pins in a box, 38 boxes. Made by Pivot Point, \$15 per box. Call Debbie or Ron at 208-771-1140

# Vacations

LAS VEGAS ROUND TRIP air from Spokane, only \$159. Air and four nights at Circus Circus, only \$319; Golden Nugget, \$379. We have 100 hotels available. Call 608-717-6145, pmtravel2009@yahoo.com

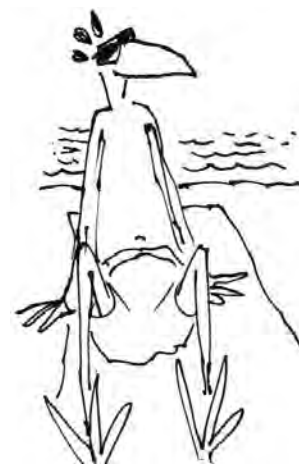

# TK AUTO Sales

509-242-3588  
TKAutoSalesSpokane.com

# SPRING SALES EVENT

OPEN Mon-Sat 9-6 • Sun 12-5  
6904 E. Sprague, Spokane Valley

## 2020 Chevrolet Trax LS

AWD, 4 cylinder, auto, Ecotec 1.4L Turbo I4  
Stock #12173



\$10,924



2016 Chevrolet Cruze Limited LTZ  
Leather, 4 cyl, auto #12753

\$9,680



2016 Scion iM  
Auto, 4 cyl, PW, sharp #12457

\$12,883



2012 Subaru Outback  
AWD, moonroof, loaded #12573

\$8,205



2013 Ford F-150  
Quad cab, 4x4, XLT #12100

\$10,990



2019 Nissan NV200 SV  
Cargo van, PW, PL, A/C #12720RB

\$10,988



2019 Chrysler Pacifica  
7 passenger, leather #12749

\$11,440



2015 Ford Explorer Limited  
AWD, 3rd seat, 109k miles #12712

\$13,665



2013 Jeep Wrangler Unlimited  
4x4, Sahara, 86k miles #12719

\$18,770

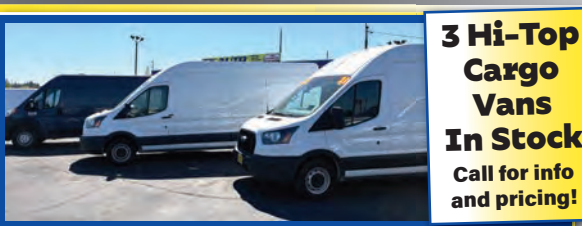

3 Hi-Top Cargo Vans  
In Stock  
Call for info and pricing!

In-house financing • Bank and credit union financing • 1st time buyer program  
Credit application online • Fast credit approval  
See our full inventory at [TKAutoSalesSpokane.com](http://TKAutoSalesSpokane.com)

\* On bank or store approval. First time buyer OAC may require up to 15% down payment. Price/payments are plus tax, title, & lic if applicable. Minimum Beacon required on approved credit. Not all will qualify, depending on year & purchase price of vehicle. VIN's posted at dealership. Subject to prior sale. Ad expires 5/22/26. Up to \$200 documentary service fee may be added to sale price.

# PREDIABETES CAPTURES 1-IN-3 ADULTS. BUT YOU CAN ESCAPE.

Take the 1-minute prediabetes risk test.  
[DoIHavePrediabetes.org](http://DoIHavePrediabetes.org)

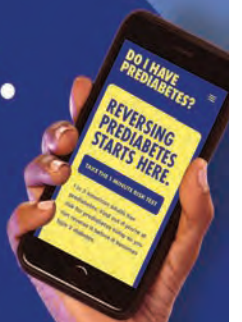

# Boats Recreational & Fishing



SEA KAYAK 16.5' LONG, 22" wide, with rudder, \$750. 208-618-1584

1994 18' OPEN BOW FOUR Winns inboard/ outboard Model 170 Freedom. Nice condition, service records, \$4000. 208-916-0338

18' FIBERFORM, \$1200 ON outdrive, needs short block, asking \$1000. 208-255-7316, leave message

HONDA 2HP SHORT Shaft 4-stroke outboard motor, \$650. Johnson 25HP 2-stroke long shaft, \$1850. 8HP Tohatsu 4-stroke long shaft, \$1850. Yamaha 9.9HP long shaft 4-stroke, \$2250. All good condition. Credit cards accepted. 208-762-5651



2000 SEA RAY 22' CABIN cruiser, galley, bed and head, low time engine in good mechanical shape, bimini top, canvas cover, plastic windows, EZ Loader 2-axle trailer. Always stored inside, ready to enjoy overnight trips on the water, \$9700. Priest River, ID, 208-304-6124

BOAT BUILDERS! Several hundred board feet of completely seasoned larch, cedar, and Doug fir. Come see, make offer! 208-266-1541

18 HORSE NISSAN outboard, 2 stroke, runs great, \$1000. 208-755-2150, Hauser Lake, ID



1973 VALCO ALUMINUM 12' with trailer. Custom hand made interior, 50 lb. thrust Minn Kota, custom redwood flooring, new battery, new seats, anchor, throw cushion, rods, reels and net, complete turn-key fishing boat, serious buyers only \$2900. 208-920-3444

LOCAL PAPER, LOCAL people, local results. The Nickel's Worth, 208-667-0651

BLACK SHEEP SPORTING Goods. Home of the lowest prices on all things outdoors. In the Silver Lake Mall, 200 W. Hanley, CdA. 208-667-7831; www.BlackSheepIdaho.com



2006 LUND FISHING BOAT, 12', Yamaha 15HP outboard, EZ Loader trailer, clean, runs great, \$3950. 208-789-9278, Rathdrum, ID

# Pets of the Week: Thelma and Louise

— Second Chance Pet Rescue —



Thelma and Louise are a bonded pair of best friends. Thelma is a 3-year-old spayed female Yorkie-poo (8 lbs) and Louise is a 3-year-old spayed female Goldendoodle (60 lbs). Both girls were picked up as strays running the streets in Utah. They were both severely matted and emaciated. They are making a full recovery here and have now been spayed and given a clean bill of health. They are looking for a home together. They travel well in the car, they are leash trained and very quiet, clean, well socialized girls. Do you have room in your heart and home for two lovely ladies? They will require regular professional grooming for the rest of their lives.

Please email [Idahocondog@yahoo.com](mailto:Idahocondog@yahoo.com) or search for Second Chance Pet Rescue, Hayden ID on [www.petfinder.com](http://www.petfinder.com) for more info and an adoption application.

# Sporting & Outdoor

SEA KAYAK 16.5' LONG, 22" wide, with rudder, \$750. 208-618-1584



ELECTRIC EBIKE 750 Xpress High-Step. New, not able to ride it, originally paid \$1400. Pedal assist with throttle 48V battery, LED screen, 27" wheel, \$800. Call 402-677-4247, Post Falls

PAIR OF FREE SPIRIT double ski water skis, like new, \$100. 208-255-7316, leave message

BLACK SHEEP SPORTING Goods. Home of the lowest prices on all things outdoors. In the Silver Lake Mall, 200 W. Hanley, CdA. 208-667-7831; www.BlackSheepIdaho.com

BERETTA 1301 TACTICAL C Model 2 semi-automatic 12 gauge, new, unfired with box, \$1500. 208-290-3576

TOP DOLLAR PAID FOR quality firearms and related items. Old gold and silver coin wanted. Call or text 208-661-4598

PLACE YOUR AD ONLINE. Visit our website at [www.nickelsworth.com](http://www.nickelsworth.com). Classifieds start at \$11.00 for 15 words (10 cents per additional word). We also have options for extended coverage in central Washington

PHOTOS WANTED! WE'RE looking for local scenery and wildlife photos for editorial consideration only. Email your images to [articles@nickelsworth.com](mailto:articles@nickelsworth.com) or text 208-667-0651 with your full name, contact info, and a short caption. While placement isn't guaranteed, all submissions are saved for possible future use. Thank you for sharing your photos with the community!

# Furniture & Appliances



TWIN HEADBOARD, white, good condition, gently used, solid wood with all hardware included, made by Stanley Furniture Company, \$125. Carefully stored after a move with bubble and cling wraps to prevent any scuffs or dings. See additional pictures online at [nickelsworth.com](http://nickelsworth.com). Call or text 208-661-5771, Post Falls

SELECT COMFORT ILE Sleep Number king size bed with adjustable base, dual side independently adjustable, \$1950. 5 cubic foot chest freezer, \$160. 7000 watt Champion generator, \$700. Husqvarna 24" Deluxe 2-stage snowblower, \$725. 208-755-6656

CHARCUTERIE/ CUTTING boards. Exotic Asian hardwoods. Three rectangular 14"x24", 1-3/8" thickness, large, \$150-\$200 each. 208-264-5771, Hope, ID, 9am



CHINA HUTCH, INCLUDES glassware, some Waterford Crystal, and complete set of Christmas dishes. \$500 for all, 208-929-8781

HELPFUL & AFFORDABLE: "We got a really good response; your paper must reach a lot of people!" Kathleen, Dec. 2025



WILD WEST HAS A HUGE selection of dining furniture in stock. So many styles. Highway 95 (between Kathleen and Dalton), 208-667-1394, [wildwestrusticfurniture.com](http://wildwestrusticfurniture.com), CdA

# Pets of the Week: Millie and Max

— Better Together Animal Alliance —



Meet Millie! She is a 5-year-old sweetheart that weighs in at 106 pounds and is ready to find her perfect home. Millie has experience as an outdoor dog and is already house trained, making her transition into a new environment that much smoother. She gets along well with

other dogs, but she would do best in a home without cats or chickens. Millie can be a little shy when meeting new people, but once she warms up, her true personality shines-she's easygoing, affectionate, and loves being part of the action. Millie enjoys an active lifestyle and would be a great companion for someone who loves swimming, hiking, or going on long walks. She also has a playful side and can't resist a good squeaky toy. If you're looking for a loyal, loving dog who just needs a little time to come out of her shell, Millie might be the perfect match.



Meet Max! Renowned for her exceptional snuggles, this sweet 13-year old lady is looking for a cozy home where she can show off her talents. Though her history with dogs is limited, she has plenty of

experience with other cats and would fit right into a home with other feline friends. Kids are A-OK, too, as long as they're on the quieter side and don't expect her to play for hours like a younger kitty would. Do beware that she likes to hunt small animals; so fish, lizard, and bird owners watch out! Other than that, ultimately, anyone wanting a cuddle buddy with a bit of an attention-seeking streak will love her! If she sounds like a good fit for your life or you'd just like to cozy up with a kitty for a while, come say hi to Max!

Animal Care Center: 208-265-7297, 870 Kootenai Cut-off Road, Ponderay, ID, 83852. Hours: Monday-Saturday noon-4:30pm. Thrift Store: 208-263-0706, 9am-6pm daily, donations: 8am to 4:30pm daily.

Learn more at [www.BetterTogetherAnimalAlliance.org](http://www.BetterTogetherAnimalAlliance.org)

# Pets

## Pets of the Week: Ollee & Hartlee and Annie

— Luke's Legacy —



**FRENCH BULLDOG SHIBA** designer pups. All of the Frenchy personality without the horrible, expensive health issues; these pups are playful, gentle, smart, and athletic. Described as the perfect puppy and best dog. Safe around children and other animals. Vaccinated and wormed, well mannered, doggy-door trained. Two males and two females now available, \$1200. Online pictures at nickelsworth.com. 208-217-0177

**AKC GERMAN LINE** Rottweiler puppies ready for forever homes. Up to date on vet check-up vaccinations and deworming. Parents genetic tested. Will deliver to CdA on May 23rd, \$2200-\$2700. Online photo at nickelsworth.com. Please text Rebekah at 406-260-6687, Kalispell, MT

**FLOCK REDUCTION.** Parakeets, \$20 each. Twelve to choose from, lots of colors. Two breeding pairs of canaries, \$150 per pair. Two pairs of green cheek conures, one yellow sided pair, \$350 each or \$650 for pair. Turquoise pair, \$750 per pair. Rosy female Bourke, DNA sexed, \$250. Breeding pair of Macaws, \$7500, includes two cages and nest box. Additional cages, nest boxes, and accessories available. Text for pictures, 509-279-3199

**WANTED: FEMALE RED/Blue** Heeler puppy with docked tail. 509-262-4417

**YORKIE TERRIER PUPPY,** one female left, 12 weeks old, \$1000. Call 208-699-0621



**(2) GERMAN SHEPHERDS** that desperately need to be rehomed. Owner passed away. Need to find a new home as soon as possible. Both are great with kids and other dogs. Pic of second dog at nickelsworth.com. 509-592-8946, Rathdrum, ID

**AKC FIELD BRED** English Springer Spaniels. Liver/white and one tri color, three males available. Parents on site, both hunters. Born 03/20/26, will be ready for their new forever homes on 5/15/26, \$1800. 971-235-9408, Post Falls, ID



**HALF ROUGH COAT** Collie half Mini Aussie pups born April 8th, ready May 31st. 5 boys, 1 girl available. Black tri, \$300; blue merle, \$500. Text Daniel, 208-627-7974, Sandpoint, ID

**AUSTRALIAN SHEPHERD.** Needs to be rehomed; red tri, \$75. 208-582-2802, or 208-916-4665

**COCKAPOO PUPPIES** Born March 8th, 2026. 2 males, 4 females, \$800, payment plans available. 208-449-5126



**AKC CHOCOLATE LAB** pups, first shots, ready to go, \$950. Call/ text for more info, 208-659-1307, Potlatch, ID

**BLACK SHEEP SPORTING** Goods. Home of the lowest prices on all things outdoors. In the Silver Lake Mall, 200 W. Hanley, CdA. 208-667-7831; www.BlackSheepIdaho.com

**GREAT PYRENEES** puppies, ready now for new homes! \$500. www.LLfarmBenewah.org, 208-784-3785, St. Maries, willing to meet



**FLOKI IS A TWO YEAR** neutered male purebred Catahoula leopard dog. He came in to rescue as a puppy, was adopted and then returned and now has been here over a year! He is a beautiful dog. Kind and very smart. He's very typical of his breed. He is housebroken, obedient and quiet. Read all about him and see more photos at petfinder.com— search for Second Chance Pet Rescue, Hayden, ID, or call 208-666-6025, Second Chance Pets CdA

**MINIATURE AUSTRALIAN** Shepherds. Two purebred males, 1.5 years old, free to good home. Call 406-280-0033

**BOSTON TERRIER PUPPY:** Male, 6 weeks old, first vaccine, ready to go. Cash only, meet in person. Serious inquiries only, please. Yakima, WA. Call or text 509-969-5788



**SCOTTIE PUPPIES.** Raised in our home. Socialized. Dewormed. Shots. Microchipped. Vet checked. AKC registered. Male and female. Black, white or tan. \$1900. Call or text Christy, 360-949-3801, CdA

**GERMAN ROTTWEILERS:** 3 male German Rottweiler puppies, born 2/23/2026, up to date on vaccines, tails docked, very reasonable price. Located in Granger, WA, willing to travel. Contact me for more info at 509-831-2489



brought current on their vaccinations and will be microchipped before they leave.

**Mini Aussiedoodles!** Both about 10-12 lbs. each. The boy is Ollee (left) and he is just turning 1 year old. His sister, Hartlee, is just turning 2. Both will be spayed and neutered and available for adoption. House and crate trained, both sweet babies. Both have a fresh groom, and were



**Annie - 5 year** old spayed female Bluetick Coonhound x Cattle Dog. The sweetest most mellow girl and would be excellent for an older person or couple. Annie is spayed, microchipped and current on vaccinations.

Call or text Erin for an application 208-755-7127 or email emwllrd@gmail.com with a letter of introduction. You can also visit LukesLegacy.care



**TOY AUSSIE PUPS:** Papared Toy and Mini Australian Shepherd puppies. One red tri toy, \$550. One black tri toy, extra tiny, \$750. One striking black bicolor mini with sky blue eyes, \$800. Will come wormed, vet checked, and up to date on shots. Call or text 509-634-0692. Located in Tonasket

**AKC CHOCOLATE LAB** puppies. Two chocolate Labs and two Lab females born April 1st, will have first shots, deworming and papers, ready May 27th. \$400 deposit to hold, \$400 when you pick them up. Call or text 509-720-9186

**BEAGLE PUPPIES:** Adorable tricolor Beagle puppies, \$850. These adorable puppies are current on their shots and wormings and will be ready for their new homes on May 16th. Please call Donny or Jackie for more info, 509-941-9977

**GREAT PYRENEES** Puppies born 3/12/26. Wormed and first shots, mom on site, great pets, \$450. 208-777-5145

**AKC ENGLISH CREAM** Golden Retrievers: Beautiful AKC English Cream Golden Retriever puppies. 8 weeks on May 6th, they can go home with you just in time for Mother's Day. Both parents on site. Genetic testing done on both parents, hips and elbows done on mother. Both parents have great temperament. \$1000 each. Call or text 206-639-7451



**GORGEOUS TEACUP** Korean Maltese Yorkie girl looking for forever home. 1 year old, up to date vaccines, not spayed, 5 pounds. Doggie door, crate, and leash trained. Very sweet girl to everyone she meets. Gets along with other small dogs. \$2000. CdA area, 305-896-4332



**MINI AUSSIES. THREE** males, first shots, \$500. 509-818-4273, Spirit Lake, ID



**AUSTRALIAN SHEPHERD** tri color puppies. Males \$50, females \$100. OBO on all. 208-964-2508

**ROTTWEILER PUPPIES:** (9) beautiful Rottweiler puppies born 4/11/2026, ready for homes 6/11/2026. Tails docked, dewormed, and first set of shots. Willing to travel. Mom and dad on site. 509-405-9268

**CAVAPOO GIRL** LOOKING for a new home: Our sweet Maple is looking for a new home. She's a 5 month old Cavapoo puppy with the absolute sweetest heart! She was the pick of the litter and you will understand why when you meet her! Her coat is no-shed with the softest curls. She's easy to train, eager to please and loves everyone! She has been seen by both vet and groomer and does great with both. She has all her shots and deworming. This girl is looking for a great family to fit her greatness! Price \$800. Call or text 509-516-6781



**HUSKY PUPPIES!** SOLID white or black and white males and females. No shots, parents on site, located in Plummer, ID. Males and females, \$100. Call or text 208-582-2243

**SHORKIES: SHIH TZU/** Yorkie mix: Male puppy \$700, female \$800. For more info, please call/ text 509-820-1034



**AKC POMERANIAN PUPPY.** Blue merle parti female, ready for a loving home. Vet checked, dewormed, current on shots. Raised in our home with love. \$3500. Text first: 208-290-1651, Bonners Ferry, ID

## Pets of the Week: Rally and Stitch

— Priest River Animal Rescue —



Rally is a handsome, gentle cat with a quiet, easygoing nature. He may be shy at first, but once he feels safe, his sweet personality shines and he'll happily purr for affection. Rally would do best in a calm, peaceful home where he can settle in at his own pace. He enjoys keeping all four paws on the ground, unless he chooses to curl up in your lap. If you're looking for a loyal companion with quiet charm, Rally may be the perfect match. Come meet this sweet boy and see how easy it is to fall in love.

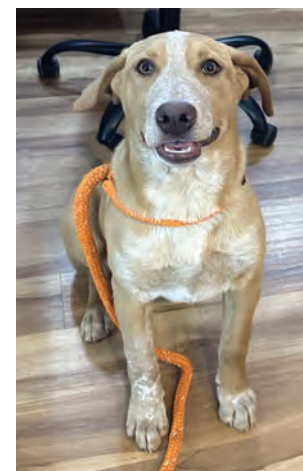

Stitch is approximately 4-1/2 months old and was abandoned with his mother before a kind family took them in. Now at the rescue, he is proving to be sweet, outgoing puppy. Because he is used to living outdoors, he does need help with leash walking, basic training, and house-breaking. Stitch is expected to grow to over 50 pounds and would thrive with an active family that has room for him to run

and time to socialize him. If you are interested, submit an application to schedule a meet and greet. He is available by appointment only.



Phone: 208-448-0699 | Email: pranimalhouse@hotmail.com  
Website: pranimalrescue.org | Address: 5538 Highway 2, Priest River, Idaho

Our hours are Tuesday through Saturday, 11:00am to 4:00pm. Walk-ins are welcome to see the adoptable animals. We have a wonderful Critters Thrift Store full of hidden treasures.

# Pets

**CHIHUAHUA PUPPIES:** (3) male Chihuahua puppies, vaccines and deworming up to date. Rehoming fee is \$650. If you have any more questions, please call 509-709-9092. Thank you

**PUREBRED ENGLISH Cream Golden Retrievers:** Both parents are AKC registered. Puppies have first shots and deworming done. \$500 OBO. Low price, no reg., pet only. Please text 509-367-9898



**PRECIOUS Goldendoodles.** Fantastic variety of colors and personalities to select from. Homebred, sweet, smart. First shots, dewclaws removed. Reasonably priced to place in forever homes. \$775. Call or text to meet. 208-771-2732, CdA

**MALTIPOO PUPPIES:** These puppies have up to date vaccines, deworming, and potty training on pads. Great with kids, seniors, and other animals. They are very loving, smart, mellow, and love kisses and cuddles. Under 10 lbs. and 1 teacup. I also have a Poodle and a Maltipoo that are 6 and 8 months, parti, trained, and all of their shots are done. You're welcome to text or call for more info. 509-845-2815

**GORGEOUS YORKIES,** small, looking for loving homes. 509-802-5913

**SECOND CHANCE PETS, Inc.** All dogs spayed or neutered. Floki, 2 year purebred male Catahoula, gorgeous, black and rust coat, one person dog; Eb, 2 year male black German Shepherd, great friendly dog! Mitzi, 1 year female Black Lab/Whippet mix, super athletic and well behaved; Tikka, 7 year old female Corgi/ Cattle Dog mix, best as an only dog, but loves people; Three 4 month old Border Collie/ Aussie stock dog mix pups: short coats, long tails, black/ white male, two blue merle, 1 male, 1 female; Ace, 1 year male Border Collie/ Jack Russell Terrier mix, white with black patches, no-shed wire coat; Poppy, 2 year black female Lab mix, three legs! Super friendly girl. Gage, 5 year male purebred German Wire-haired Pointer, fantastic manners; Spot, 8 month male Australian Cattle Dog mix, one blue eye! Thelma and Louise, bonded pair of females, one Doodle and one Yorkie mix. Barney, 2 year old male Havanese/ Pekingese mix; Betty, 2 year old female Pekingese mix; Punky Brewster, 6 month old female Jack Russell Terrier/ Chihuahua mix, non-shedding wire coat. You can search for Second Chance Pet Rescue, Hayden, ID on petfinder.com, or email idahocondog@yahoo.com for information



**WHITEWOLF HUSKY Haven Rescue.** Husky pups, shelter rescues. All ages. Call for details, 208-597-5509



**MINI SCHNAUZER Puppies,** \$750. Text/ call 509-780-7474. Deworming treatment and vaccination, dewclaws removed, tails docked. Pay when you pick up. Asotin, WA

**BEAUTIFUL SHIH-POO puppies** looking for a new home. 8 weeks old, vaccines up to date and dewormed. Asking \$500 per puppy. For more info, send a message to 509-380-2349 or 509-948-3227



**DO YOUR RESEARCH!** Make sure you are really ready for a new pet before bringing one home! Also consider adopting a pet from a shelter: They are full to bursting with many pets just waiting for a family to take them home and love them!

**CAVAPOO PUPPIES READY** to go home now: We have 2 female Cavapoo puppies looking for great homes! They are ready to go home today. The puppies were born March 14th and have had lots of early socialization. They are raised around kids and others dogs and have amazing personalities, just eager to please and bring joy to your home! All puppies have been health checked by a vet and come up to date on vaccines and deworming. Price \$1200. Contact me at 509-516-6781

**MALE DALMATIAN.** ONE year old, gets along with other animals and is very friendly around people. Loves kids and is up to date on vaccines. Rehoming fee is \$700. He's looking for a forever home with a big fenced-in yard. 509-900-4196, located in Yakima

**NORWEGIAN ELKHOUND/ Border Collie mix** pups ready for their forever homes June 1st. Will have first shots and be dewormed. Hermiston, OR. Text 509-745-5373 for more info



**VALENTINE'S DAY puppy!** Last one of the litter. Loving home needed! Quality mixed breed (ABKC Pocket Bully dam with AKC Cane Corso sire, 7+ generation pedigree). Family raised, well socialized, parents on site. \$400 rehoming fee which includes vet care. Call or text 347-738-2234, Spokane

## Pets of the Week: Finley and Mystique

— Hope's Haven Animal Shelter —



Meet Finley! She is a 3-1/2 year old Lab/ pitbull mix. Miss Finley is a VERY energetic dog, so she will need to go home with someone who is active and adventurous! She loves going on runs and playing in the yard. She cannot go to a home with ANY other animals, due to her high prey drive and dislike of other dogs. Finley has a lot of potential, she just needs someone willing to work with her and give her the time and attention she needs. If you have no other animals, a fenced yard, and lots of free time, Finley might be the girl for you!



Meet Mystique! She is a 8 year old tortoiseshell domestic long hair. Mystique came in with her housemate Sunshine, who is semi-bonded to her. They both love to lounge together and love on each other, but also like their separate alone time. Mystique did have some pretty severe matting when she first came to us, which is why she now has that super stylish "lion's cut."



Hope's Haven Animal Shelter (Benewah Humane Society) is open Monday-Saturday, noon-4pm. Come into Hope's Haven to visit and view our animals or check them out first on our website. Give us a call for more information today!

Phone: 208-245-7387 | Email: [hopeshaven@smsgazette.com](mailto:hopeshaven@smsgazette.com)

Website: [benewahhumanesociety.com](http://benewahhumanesociety.com) | Address: 53 Robinson Ln, St Maries, ID

**BEAUTIFUL AKC SHIH Tzu** babies ready to go. Come with shots, deworming, health guarantee contract, and lifetime breeder support. From health tested parents. For more info text 503-583-5091, Ellensburg, WA



**AKC POMERANIAN PUPPY.** Blue merle parti male, ready for his loving home. Vet checked, dewormer, current shots. Raised in our home with love. \$1500. Text first, 208-290-1651, Bonners Ferry, ID

**YORKIE PUPPY** looking for forever home. Male, born 8/31/25, has all shots and dewormed. Very playful and likes to cuddle. Great around other dogs. For more info: 509-380-1577

**YORKSHIRE TERRIER:** Male Yorkie puppy, \$700. For more info, please call/ text 509-591-1363



**OLDE ENGLISH Bulldogge** puppy. IOEBA registered Blue Ribbon parents on site. 1 male ready now, vet check and vaccinations included, \$2000. Visit our Facebook kennel page: [AlpineBullys.com](http://AlpineBullys.com). Athol, ID. 208-216-9826

**GOLDENDOODLE Puppies:** Beautiful Goldendoodle puppies looking for their new forever homes. Well handled by children, parents have great temperaments. Located in Prosser, WA. Asking \$800. Text 503-569-2674

**BEAUTIFUL AKC Frenchie** babies. Come with shots, deworming, puppy starter pack, health guarantee and lifetime breeder support. Health tested parents. 503-583-5091, Ellensburg. [www.oceanbluebulliesllc.com](http://www.oceanbluebulliesllc.com)

**WE HAVE SOME beautiful** Maine Coon hybrid kittens ready to go. Have had shots, dewormed, litter box trained, raised around kids and other animals. All are super friendly. For more info: 509-201-0885, Ellensburg

**LABRADOODLES FOR Sale!** Adorable Labradoodle puppies for sale. Dewclaws removed, first shots, dewormer, and microchips. Ready Mother's Day weekend! Some very snuggly babies, some very adventurous, all very social and full of personality! 4 females, 3 males. Asking \$650. Text or call Charity for more info and pics at 509-820-8258

**PEKITZU BABIES, ALL** will be under 10 lbs., have had shots, dewormed, have health guarantee, already puppy pad trained, very social. For more info text 503-583-5091, Ellensburg, WA

"WE LOVE YOUR PAPER!" That's how we have been able to find a lot of great contractors for our house. I love reading the paper and love that we still have this local resource!" Nicole, November 2025

**MICRO BERNEODOODLE** puppies for sale: Micro Bernedoodle puppies available, \$3000. Burbank, WA. Message/ call 509-430-7204. Burbank Bernedoodles

## Antiques

**BUYING OLD US COINS.** Graded and ungraded. Will look at entire collections. Call Mike at 801-808-0343, Post Falls

**COMIC BOOKS WANTED!** Paying cash. Large or small collections. Any age, but the older the better. Fair cash offers. Call or text Rob at 208-920-1362, [robthewretched@yahoo.com](mailto:robthewretched@yahoo.com)

JUNE 11TH

# SUMMER

Business Card Book



We listened!

NEW LOWER PRICE:  
NOW JUST \$50  
PER AD SPOT

With an issue for every season, the quarterly Nickel's Worth Business Card Book is an excellent and economical avenue for advertising. We distribute the booklet with the paper and it's available on our website the entire quarter.

- Full color ads the size of a business card
- Need more room? You can get up to 8 spots
- Great branding! Get your name in front of our local, invested audience

Please have ads in by June 4th

CONTACT US TODAY TO GET YOUR AD IN!

208-667-2408 | [www.nickelsworth.com](http://www.nickelsworth.com)

107 N. 5th St., Coeur d'Alene

## Pets of the Week: Sweet Tea and Smokey

— Companions Animal Center —

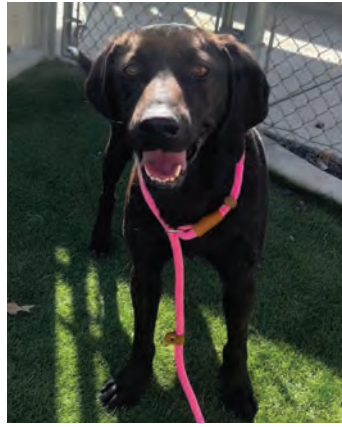

Sweet Tea is a 3-year-old hound with a heart as warm as her name. She's a truly nice girl who's ready to start her next chapter with a loving family. This energetic pup has plenty of pep in her step and would thrive in a home that can keep up with her playful spirit. Whether it's going on adventures, exploring the outdoors, or just burning off some zoomies in the yard, Sweet Tea is always up for fun.



Smokey is a very sweet 13-year-old girl. She would do best in an adult only home. We believe that she would do okay with dogs, although she would need a very slow introduction but would need to go to a home with no other cats. Smokey loves to lounge around sleeping, as well as loving to receive nice pets and cuddles.



Companions Animal Center is located at 10275 N Atlas Rd, Hayden, ID. We are open to the public Tuesday-Saturday noon-6pm, Sunday noon-4pm, and closed Mondays. Visit [www.companionsanimalcenter.org](http://www.companionsanimalcenter.org) or call 208-772-4019 for more information.

### ATTENTION STOCKMEN!

## SMALL ANIMAL/ REGULAR SALE

Wednesday, May 27th • Noon

SPECIAL FEEDER SALE ..... Wednesday, June 10th

### Lewiston Livestock Market

208-743-5506 ANYTIME | John Pearson: 509-288-0161  
Tate Witters 509-780-7293 | Doug Kinzer 208-790-3615  
LLM@lewistonlivestock.com | [LewistonLivestock.com](http://LewistonLivestock.com)

## Farm Animals



**MERRITT 40' LIVESTOCK** trailer, double deck, older farm trailer, \$8500. 208-651-8698, no texts

**WANT COW CALF TO Graze** my pasture this summer. Will buy calf and you retrieve cow. You deliver to my property near the Moscow Pullman airport. 509-330-6164

**BARNYARD MIX** Straight run chicks, \$10 each, feathered and ready for a coop. Kune Kune boar, under one year, \$175. Seven Kune Kune weaner piglets, \$150 each, ready to go 5/22. 509-279-3199

**BEAUTIFUL PUREBRED** Highland bull, 13 months old. Unregistered with registered sire and full Highland mother on site. He is very gentle and loves to be scratched and petted. \$2600, consider trades. Phone 208-476-7480 for more info, Spirit Lake

**DAIRY SHEEP, EAST Friesian** female lambs, \$250 each. Milking ewe, \$1000. Call or text 208-597-5670

A NEW ISSUE OF THE Nickel's Worth, every Thursday

**FARM ANIMALS FOR sale:** Reliable egg layers, chicks available now, \$4 each: Rhode Island Red, Light Brahma, Midnight Majesty Maran, and Lavender Orpington. Turkey poults \$10 each: Royal Palm and Blue Slate. Ducklings \$8 each: Blue Swedish, White Crested, and Magpie. Nubian kids, friendly from high producing dairy lines, \$100. Text or call 406-531-9269



**BRAND NEW 12' STEEL** corral panels, portable, green in color, \$110 each, until sold. 208-651-8698, calls only, no texts

**WANTED: FEMALE RED/** Blue Heeler puppy with docked tail. 509-262-4417

## Hay & Feed

**TOP QUALITY FIRST AND** second cutting irrigated alfalfa. Regular 70 lb. bales, also lots of round bales. \$200-\$275 per ton, load by appt., Post Falls. 208-964-4902, 208-659-2846

**YOU'LL ALWAYS TALK TO** a real person at the Nickel's Worth! Never automated! 208-667-0651

**MASSEY HESSTON BALER** Model 1838 small square inline. Like new, only 12,000 bales, \$20,000. Ed, 208-659-3840

**ALFALFA, BARN STORED,** \$10 bale, 4x5 round bales, \$100. 208-773-3663

**BARN STORED, LADY sized,** 70 lbs. orchard grass or Timothy, \$300. 509-445-1148, Usk, WA

**SMALL SQUARE BALES of** straw, \$6 bale. Wheat and barley. Will machine load flat beds. 208-661-6616, south of Bonners Ferry

## Horses & Tack

**BROODMARES/ Yearlings,** making room: 16 year old AQHA registered chestnut mare, \$3500; 12 year old registered APHA black and white mare, \$3500. APHA registered black and white colt, homozygous black and tobiano, \$7500. AQHA/ APHA registered buckskin colt, \$5500. AQHA/ APHA registered palomino colt, \$3500. APHA perlino filly, \$4500. World Champion bloodlines. Text for pics, pedigrees, and more info. Payment terms available. 509-279-3199

**3-HORSE SLANT HORSE** trailer, \$5000 OBO. 208-699-4177

**PINE CHIPS FOR BEDDING** 16 yard loads, delivered, \$200 plus mileage. 208-660-5554, leave message



**GENERAC**

**#1 standby generator worldwide.**

Get whole-home power, automatically.

Call 866-643-0438 to schedule your free quote today!

\*Terms & conditions apply



Custom Smoked Sausage & Jerky

**"Retail & Custom Meats"**

Now Featuring Local USDA Buffalo & Elk

**Tim's Special Cut Meats**

208-772-3327 • 525 N. Graffiti, Post Falls (Behind Taco Bell)

**Transform Your Bathroom and Change Your Life.**

**FREE TOILET + \$1,500 OFF\***

For your FREE information kit and our Senior Discounts, Call Today Toll-Free

**1-855-417-1306**

\*Free toilet with purchase and installation of a walk-in tub or walk-in shower only. Offer available while supplies last. No cash value. Must present offer at time of purchase. Cannot be combined with any other offer. Market restrictions may apply. Offer available in select markets only. CSLB 1082165 NSCB 0082999 0083445 13VH11096000

*Seasonal Scrapbook* Get Your **NICKEL'S WORTH**

**SPRING**

Share the beauty of spring in the Northwest with the Nickel's Worth!

Our 2026 Seasonal Scrapbooks—showcasing the unique beauty of our local seasons—continue with the spring edition, out in the May 29th paper. If you have spring photos and poems to share, we'd love to include them!

You can email ([articles@nickelsworth.com](mailto:articles@nickelsworth.com)), text (208-667-0651) or mail (Nickel's Worth, PO Box 2048, Coeur d'Alene, ID 83816). Please have everything in by Monday, May 25th and call 208-667-2408 if you have any questions.

*The Nickel's Worth* [nickelsworth.com](http://nickelsworth.com)  
208-667-0651 or 208-667-2408

**Your Tomorrow Matters.**  
**IF YOU NEED HELP RIGHT NOW, PLEASE CALL THE NATIONAL SUICIDE PREVENTION LIFELINE:**  
**988**  
**OR**  
**TEXT "MT" TO 741-741**

# Americanisms



"If you can't be kind, at least be vague."  
 — Judith Martin

## Apartments For Rent Including Duplexes & Condos



**CDA DUPLEX, 2 Bedroom, 1 bath, newly painted, new carpet and vinyl, garage, nice neighborhood, \$1525 month. Downtown CdA studio apartment, new carpet, newly painted, good location, \$1095 month, WSG flat rate of \$70. 208-667-2550**

**AW, YOU REALLY LIKE US!** "Thank you very much! You guys are always good!" Mark, December 2025

**GREAT LAKEFRONT studio apartment between CdA and Sandpoint. Furnished, no smoking. \$880 month, includes utilities. Nice place to ruminate. 208-651-8701**

**CDA 2 BEDROOM, 1 BATH duplex with fenced yard. 12-month contract, \$1200 month, includes some utilities. Please call 208-664-5115 (landline) for more information**

**TRIPLEX, 2 BEDROOM, 1.5 bath, W/D, garage, dishwasher and fridge included. Owner pays WSG. 1144 W. Sumac, CdA. No smoking, no pets. \$1600 month. 208-651-8896**

**NICKEL'S WORTH reserves the right to amend any ad to adhere to the Idaho Fair Housing Laws. Ads may not discriminate in any way due to race, color, religion, sex, handicap (including service animals), national origin, marital or familial status (having children, single), etc.**

## Manufactured Homes & Spaces



**MAY SPECIAL: PET Owners alert! Seller will pay lot rent for the rest of 2026 with an accepted offer by 5/31/26, a value worth thousands! 74 E. Walrose Loop, Hayden. Charming 2 bedroom, 1 bath manufactured home just off Government Way. Move-in ready with a fully fenced yard (grandfathered in, no new fences allowed), irrigated garden, 12x12 shed, paved parking, and built-in doggy door. A rare pet-friendly opportunity in Hayden! Additional photos online at nickelsworth.com. Call Jacob Fortenberry, Coldwell Banker Schneidmiller Realty, 208-757-6060**

**FREE MOBILE HOME frames, you cut and remove. 208-265-9318**

**NICE SPACE FOR LEASE for new manufactured home in CdA senior park near Fred Meyer. 208-772-3832**

**WE BUY FIXER-UPPER mobile homes in any park, any condition, Kootenai County area. We pay cash! 208-691-3016**



**Liz Buys HOUSES**  
**Need Cash Quickly?**  
 Get a cash offer for your house within 24 hours.  
**833-359-4707**

## Acresage Farms & Timberland

**LOG CABIN IN THE Woods, 320 sq. ft. (about 16'x20') on hard to find 10 acres in the Priest Lake area. Borders state land on one side with private land and small lake access on the other. Good hunting, fishing, snow shoeing, ATV, or just a getaway. Dry cabin, generator, water tank, outdoor shower, wood stove and/or propane heat. End of the road privacy, attached carport, one out building for storage and outhouse. Private sale, no agents. \$385,000. 208-755-0464**

**"WE LOVE YOUR PAPER!** That's how we have been able to find a lot of great contractors for our house. I love reading the paper and love that we still have this local resource!" Nicole, November 2025

**TWO ADJOINING 5 ACRE parcels to sell as one 10 acre parcel. Selectively logged, Forest Service on 2 sides, 1 of other sides is a surveyed line. Quartz Creek, Priest River area, \$165,000, may take older 4WD 3/4 ton pickup truck in on part trade, must be in very good condition. Call Mike, 208-448-0977**

**(2) 10 ACRE PARCELS IN Cocolalla. Trees, level, and only one half mile from Hwy 95. \$290,000 to \$320,000 each. 208-265-9318**

**BY OWNER: 10 ACRES ON flat land, Spirit Lake area. 5 acres clear, 5 acres timber. Flat and quiet, would consider splitting and selling the back timbered 5 alone. 208-691-1655**

# Classified Ad Form



**Ad Category** \_\_\_\_\_ See our index on page 2 for a list of categories

**Ad Copy** \_\_\_\_\_

\_\_\_\_\_

\_\_\_\_\_

\_\_\_\_\_

\_\_\_\_\_

**Phone number or email for ad:** \_\_\_\_\_

**Customer / Business Name** \_\_\_\_\_

**Billing Address** \_\_\_\_\_

**Phone (\_\_\_\_) \_\_\_\_\_ Alternative Phone (\_\_\_\_) \_\_\_\_\_**

**Email** \_\_\_\_\_

Note: The Nickel's Worth requires a legal personal or business name, address and phone number to run any ad. We will use this information solely to contact you regarding your advertising and account with us. We will not share, distribute or sell your information.

- Bill me by mail     Bill me by email  
 Check enclosed     Cash enclosed     Call me for payment info

**How to submit your ad:**    **Online:** www.nickelsworth.com

**By mail:** PO Box 2048, Coeur d'Alene, ID 83816    **By email:** ads@nickelsworth.com

**In person:** 107 N. 5th Street, Coeur d'Alene, ID 83814    **By text:** 208-667-0651

**By phone:** 208-667-0651 or 208-667-2408 (display)    **By fax:** 208-765-6969

**Deadlines:** Nickel's Worth (North ID, eastern WA, western MT): Wed., 3pm - Giant Nickel (central WA, online only): Tues., 4pm

Copyright ©2026 All content of Nickel's Worth is copyrighted material. No part of this publication may be reproduced without permission from the copyright holder. Copying or reprinting content for purposes other than personal use or internal reference without the prior written permission of The Nickel's Worth is forbidden. The words "Nickel's Worth", the typeface and the design in which they appear are registered trademarks of Nickel's Worth, Inc. Nickel's Worth reserves the right to categorize, to edit and to reject advertising. No classified ads accepted with special spacing, punctuation, headings, etc. We will not be responsible for errors, except to the extent of the cost of the first insertion of the ad. Refunds issued via check through mail or to credit card used for original purchase.

### Classified Ads

<b>First 15 words</b>		<b>\$11.00</b>
Additional words	x 10¢ = \$ .	
<input type="checkbox"/> Online-Only Pictures (Up to 5) <b>Add \$5.00</b>		\$ .
<input type="checkbox"/> Featured Online Highlight <b>Add \$5.00</b>		\$ .
Cost per week		\$ .
Number of weeks		
<b>TOTAL COST</b>		<b>\$ .</b>

<input type="checkbox"/> <b>Add the Giant Nickel first 15 words</b>		<b>\$9.00</b>
Additional words	x 10¢ = \$ .	
Cost per week		\$ .
Number of weeks		
<b>TOTAL COST</b>		<b>\$ .</b>
<b>TOTAL AD COST</b>		<b>\$ .</b>

### Picture Classified Ads

<b>First 30 words and a color picture</b>		<b>\$22.00</b>
Additional words	x 10¢ = \$ .	
<input type="checkbox"/> Online-Only Pictures (Up to 5) <b>Add \$5.00</b>		\$ .
<input type="checkbox"/> Featured Online Highlight <b>Add \$5.00</b>		\$ .
Cost per week		\$ .
Number of weeks		
<b>TOTAL COST</b>		<b>\$ .</b>

<input type="checkbox"/> <b>Add the Giant Nickel first 30 words</b>		<b>\$14.00</b>
Additional words	x 10¢ = \$ .	
Cost per week		\$ .
Number of weeks		
<b>TOTAL COST</b>		<b>\$ .</b>
<b>TOTAL AD COST</b>		<b>\$ .</b>

Beautiful New Nordman Home, 3641+/- sq ft with 6 bedrooms—2 master suites and 4 full baths with a half bath on each floor. Offering privacy, seclusion and close proximity to so many North Idaho activities. This home in "The Woods at Priest Lake" is close to Reeder Bay, Priest Lake Golf Course, Elkins Resort and a grassy airstrip. Ready for side-by-side rides in the summer and winter. Attached 18x44 RV storage/ shop for toys and watercraft.



**\$925,000** MLS #25-8889

Spacious Spirit Lake home offering it all, 3-bedroom, 2-bath rancher with 2,160+/- sq ft on 5 treed acres for privacy. 2-car garage with all-paved access from Highway 41. For car enthusiasts or buyers with recreational equipment, 2 large 40x60 outbuildings with lean-tos and roll up doors. Horse runs, panels, and fencing are already in place. 400-amp service, a heat pump, and a new Kuma wood stove. 10-12 gpm private well with a 1.5 horsepower pump installed three years ago.



**\$1,100,000** MLS #26-2068

**JOE DOBSON** | 208-661-0650 | jdobson.cbida.com  
 COLDWELL BANKER SCHNEIDMILLER REALTY

# Real Estate

**WILHELM'S CREATIVE** Home Renovations, LLC. Contractor license #1871997. Happy to help you with spring projects, handyman services, remodels, additions, custom decks, doors, windows, trim work, new construction. Over 30 years experience. Post Falls native. Home of the "Call today, get your estimate today." 208-625-8733 or 208-582-1666

HAVE SOMETHING to sell/trade? Looking to buy? Try the Nickel's Worth, it works! 208-667-0651 or www.nickelsworth.com

**BLACK SHEEP SPORTING** Goods. Home of the lowest prices on all things outdoors. In the Silver Lake Mall, 200 W. Hanley, CdA. 208-667-7831; www.BlackSheepIdaho.com

**REASONABLE RENT!** 3 bedroom, 2 bath, full unfinished basement, large open lot. 505 N. Elm Rd., Post Falls. \$2125 plus \$150 sewer and water per month. Call 208-667-6035 or 208-661-0099



I AM SPECIFICALLY trained to serve the needs and interests of real estate sellers and home buyers 50+. If you need help downsizing or restructuring with buying or selling a home, and any help with senior housing depending on your needs, I can help guide you in the right direction. I have recently received my Senior Real Estate Specialist (SRES) designation. I have worked with the senior population for over 25 years in the banking industry, insurance industry, and serving the senior population as an administrator for a senior community for over 15 years. I can help guide you or get the information you need in your transition. Please give me a call today and I would be happy to help. I am your SRES specialist! Brenda Hauck, Realtor, The Experience Northwest. 208-964-6738 or Hauckrealestate@yahoo.com

**SOLD**



**CENTURY 21** Beutler & Associates



Mark Hughes  
 (208) 208-8821



**10 ACRES COMMERCIAL!**  
**Owner will carry at 5%**

Ten acres of gently sloping and partially treed special purpose land, which backs up to Silverwood Theme Park! This is the perfect location for a campground or RV park, or storage units or simply run your small business from this location. Conveniently located between Coeur d' Alene and Sandpoint, this is a great investment for development and business opportunities, located next to the most popular theme park in the Inland Northwest. Sold - escrow fell out, no fault of seller.  
**MLS 23-9160 - 28789 N. Hwy 95, Athol, ID**

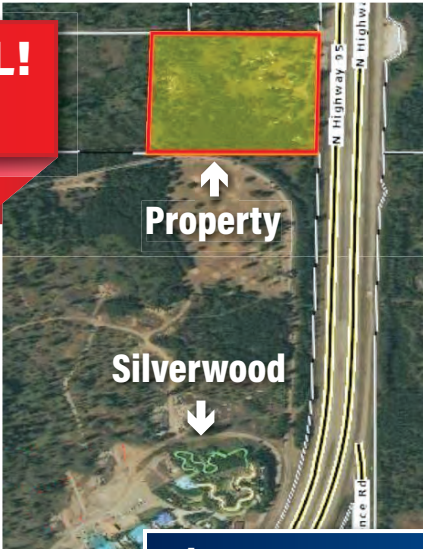

**\$1,200,000**

**Randy Cox, 208-699-1424 - Coldwell Banker Schneidmiller Realty**

## Camping closed at Swinging Bridge FAS May 1st-July 23rd

— Montana Fish, Wildlife & Parks —

**BILLINGS** – Swinging Bridge Fishing Access Site (FAS), located on the Stillwater River south of Columbus, will be closed to camping from May 1 to July 23. The site restriction was approved by the Montana Fish and Wildlife Commission on April 16th.

Swinging Bridge FAS is located downstream of Whitebird FAS. Both sites are popular with boaters, recreationists, and anglers, especially in the spring and summer. Whitebird FAS is currently limited to walk-in access only due to structural damage on the access bridge into the site. This restriction at Whitebird FAS will be in place until the bridge is repaired or replaced and is safe for public use.

Swinging Bridge FAS will likely experience increased public and commercial use due to displacement of boaters, recreationists and anglers from Whitebird FAS. The restriction closes camping at Swinging Bridge FAS to allow for increased day-use of the site from May 1 until July 23, 2026, to reduce conflicts through peak rafting and recreation season on the Stillwater River.

For more information on restrictions and closures at FWP sites, visit: [myfwp.mt.gov/fwpPub/allRestrictions](http://myfwp.mt.gov/fwpPub/allRestrictions).



### Storage Units & Space For Rent

**COMMERCIAL SPACES:** 1600 sq. ft. heated shops/warehouses. One with 10x10 overhead door, office, bathroom and gas heat, and one with two 10x12 overhead doors, bathroom and gas heat; \$1000-\$2000 per month with one year lease. All located on Government Way between Dalton and Hanley Ave. on east side. 208-664-3333 or text 208-818-5793

**INTERIOR DECORATING** business closed! Having auction of storage units: antiques, furniture, glassware, accessories, decor, etc. Call Lee, 254-265-4918 for appointment at units in CdA area. Up to 10 units! Plus large garage sale coming soon!

**ANGELA KING**  
 PRINCIPAL BROKER | KING REALTY

Curious about how much equity you have in your house? Call me today for a market update. I have buyers waiting for your property!

208-967-4224 | 208-772-4905  
 angelaking@kingrealty-homes.com  
 www.kingrealty-homes.com



**SAM INMAN HAS SOLD** over 228 million in sales and 750 homes. I've been a top producer over 20 years. Please call or email for a free comparable market analysis and my aggressive marketing plan. Sam Inman, Associate Broker, Windermere Hayden LLC, at 208-699-2651; email: [inman@windermere.com](mailto:inman@windermere.com); [www.InmanWindermere.com](http://www.InmanWindermere.com). Information provided by the CdA Multiple Listing Service

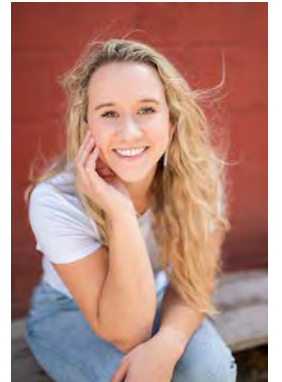

**LOCAL NORTH IDAHO** Realtor: I'm Rebeca Odenthal and I'm with Century 21 Beutler & Associates. Contact me for a free market analysis on your home or questions on homes currently listed! 208-946-8355



**MONTANA SPECIALTY** Log Construction specializes in log homes, cabins and restoration. Serving the Northwest. [MontanaSpecialtyLogHomes.com](http://MontanaSpecialtyLogHomes.com), 406-847-2316

**Celebrate YOUR GRADUATE**



Your high school graduate has worked hard to get here, celebrate their achievement with a picture in the first-ever Nickel's Worth Graduate Showcase! We'll print local graduates' pictures with their names, schools and a short message in our May 28th issue. It's only \$25 to have your graduate included, and we have an easy online form for submissions at [bit.ly/4mabJL1](http://bit.ly/4mabJL1). Please have everything in by Thursday, May 21st, and give us a call if you have any questions!

208-667-0651 • 208-667-2408  
[www.nickelsworth.com](http://www.nickelsworth.com)

get your **NICKEL'S WORTH**



**Jacuzzi** Bath Remodel

**Safety. Style. Stress-Free Installation.**

**CALL NOW 1.866.753.9521**

**SPECIAL OFFER**  
**Waiving All Installation Costs!**

Add'l terms apply. Offer subject to change and vary by dealer. Expires 12/27/26.



## Keeping Warm

RED FIR, TAMARACK, AND mixed firewood. Honest cords, very reputable seller. Give us a call or text, 208-809-9706

NOW APPROVED IN Washington! Lower your heating bills and enjoy smoke free indoor comfort with the proven technology of a Classic Edge Titanium HDX Outdoor Wood Furnace. For a limited time, up to \$3400 in savings. Call DIWH Heating today for details! 208-946-5550

THIS WEEK ONLY! Premium mostly Buckskin red fir, cut of a log deck to your desired length, \$245 cord. Delivered to surrounding CdA areas. 208-964-1607

PEOPLE LOVE THEIR Nickel's Worth! "I appreciate your service and have had great success using the Nickel's Worth. You are my go-to and I have great respect for your customer service." Jason, Oct. 2025

STIHL MS 462 R Chainsaw, excellent condition, \$1360. Brand new Husqvarna 562 XP 24" chainsaw, \$880. 572 XP 28", \$1080. Like new 16" Stihl chainsaw, \$200. 4000 watt Champion generator, \$400. Like new Kohler wheelbarrow air compressor, \$1000. Like new medium size 6.5HP 13 ton log splitter, \$850. Tune-up and repair on chainsaws and snowblowers. Accepting credit cards. 208-762-5651

FIREWOOD FOR SALE. Red fir \$175. Pine \$135. White fir \$100. All a full cord, in the round; you haul. 907-502-0146, Kootenai County

NEW IN CRATE 32" portable band saw mill, \$4450, or \$5450 with trailer kit. Small Quadra-Fire 2000, \$1150. Large Fisher Grandma Bear fireplace insert/ wood stove, \$1350. New 20" bar and chain combos to fit Husqvarna and many other saws, \$60. New chainsaw safety chaps, \$85. New Craftsman electric chainsaw, \$60. Stihl 039 gas chainsaw, \$650. Lennox oil furnace, \$600. Older Riteway wood furnace, \$980. Nice Vermont Castings Aspen 1920 wood stove, \$1750. Tune-up and repairs on chainsaws and snowblowers. Accepting credit cards, 208-762-5651

**SMOKE SIGNALS CHIMNEY CLEANING SERVICE, REPAIRS & INSPECTIONS**

Insured - Bonded  
All Calls Returned  
• Reasonable  
• Senior Discounts

**208-762-4157**  
ASK FOR KEN



STIHL 18" MS 170 chainsaw, \$260. Near new 25 ton towable log splitter, \$1400. Osburn pedestal style woodstove, \$950. Stihl 16" gas chainsaw, \$175. Huge Stihl 084 chainsaw power-head, runs great, \$1450. New Alaskan chainsaw mill, \$260. Stihl 044 Magnum chainsaw, \$900. Stihl 029 25" chainsaw, \$470. Echo 14" top handle chainsaw, \$280. Like new medium size 6.5HP 13 ton log splitter, \$850. Replacement cylinder and piston kits, carburetors, files, bars and chains for many chainsaws. Tune-up and repair on saws. Visa, MasterCard, Discover accepted, 208-762-5651

NEXT YEAR'S WOOD, CALL for details, several different prices and lots of it. Give us a call! 12 cords of wood ready to burn immediately, \$2300 custom cut red fir. 208-660-4740

## Computers & Electronics

**North Idaho Computer Repair**

LOCAL, FRIENDLY AND affordable computer repair company established in 2015. We offer PC sales, virus removal, data recovery, website design, custom PC builds, and more! Athol, Bayview, Hayden, Rathdrum, Sagle, Spirit Lake, and surrounding areas. 208-557-4254

A1 CAMERA REPAIR, CDA. Free estimates. 40+ years experience cleaning and service for digital and film SLR cameras. I buy used cameras and lenses. Call 208-640-3838 for appointment

HELP WITH YOUR Technology, tablets, smartphones or TVs, and Wi-Fi. Computer specialist with 25 years of experience. A+ certified, retired teacher. Diagnosis free. Senior discounts. Computer repaired or upgraded. Have a virus or need your computer cleaned up? No job too small! In-home assistance with hardware, wireless, photos, or instruction on any software or technology needs. \$45 per hour. Tutoring \$25 per hour; \$40 for 2 hours. Call Julie at 208-661-1765



WE FIX COMPUTERS AND laptops. Local, trusted, veteran and family owned, established in 1995. Free diagnostics. PC computer repair. We help with all technology issues. 10% discount, mention Nickel's Worth. Call PC Tune 208-717-1581

## Wanted

NEEDED: THIS AD IS NOT for a job, it's for a private teacher for the month of May or June 2026, someone who works with QuickBooks for a business (in Kootenai County) and has extensive knowledge in how to teach what they know. Perfect side job for extra income. Call 702-521-3789, CdA

WANTED: ANY BOULDERS! 2 to 4 feet, different species. Have equipment, will travel throughout Kootenai County. Call Aaron at 208-704-6528

DON'T THROW AWAY your old work jackets. Buying your used Carhartt, Dickies, Walls pants, jackets, painters' pants, overalls, coveralls, etc. Paying cash. Call 208-660-6457, CdA

RETIRED GENTLEMAN would like to buy a pre-2005 Buick Park Avenue, excellent condition, low miles. Thank you. Spirit Lake, ID, 406-581-2770

HELPFUL & AFFORDABLE: "We got a really good response; your paper must reach a lot of people!" Kathleen, Dec. 2025

A1 CAMERA REPAIR, CDA. Free estimates. 40+ years experience cleaning and service for digital and film SLR cameras. I buy used cameras and lenses. Call 208-640-3838 for appointment

**\$CASH PAID\$**  
for old fishing lures, rods & reels  
One piece or whole collections  
**406-291-9619**

Monday 2 9 10 11 16 17 23 24 22 30 31

**Check our calendars for local events.**

**Superior Built Buildings, llc** Call Now and Get on The Build List • Don't Delay!

RCE 58754

30' x 40' x 14' • 2 - 12' x 40' Lean-to's

40' x 60' x 16' with a 14' x 60' Lean-to

**WE BUILD EVERY MONTH OF THE YEAR!**

YOUR "DREAM PROJECT" Needs To Be Scheduled "NOW!" for Completion this year!  
"Engineered Plans need to be Created, Trusses to be Built, A Correct and Proper Building Pad has to Be Made!"  
Get a **Building Start Date RESERVED!** We Help Take Care of All The Details For You!  
**Don't Delay - Call Today!**

30' x 40' x 14' • 2' Overhangs-Wainscoat

40' x 50' x 16' Barn Style

30' x 40' x 14' • 30' x 12' Car Port

36' x 40' x 14' • 2 - 12' x 40' Lean-tos

• Under Construction •  
3,000 sq ft living area  
2,400 sq ft shop  
1,400 sq ft covered parking

**BARNDOMINIUM SPECIALISTS!!!**

• 208-981-0102 • 1-888-533-6080  
**www.SuperiorPoleBuildings.com**